

# URBANISTIČKO - TEHNIČKI USLOVI

GLAVNI GRAD PODGORICA  
SEKRETARIJAT ZA PLANIRANJE PROSTORA  
I ODRŽIVI RAZVOJ  
Broj: D 08-332/23-1716  
Podgorica, 12.10.2023.godine

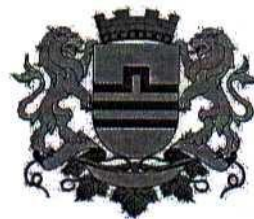

<b>SEKRETARIJAT ZA PLANIRANJE PROSTORA I ODRŽIVI RAZVOJ GLAVNI GRAD PODGORICA</b>	
na osnovu člana 74. Zakona o planiranju prostora i izgradnji objekata ("Sl.list CG" br.64/17, 44/18, 63/18,011/19, 082/20, 086/22, 004/23), Uredbe o povjeravanju dijela poslova Ministarstva održivog razvoja i turizma jedinicama lokalne samouprave ("Sl. list CG", br. 87/18,28/19, 75/19, 116/20 i 76/21, 141/21), DUP-a "Zabjelo 8", evidentiran u Registru planske dokumentacije Ministarstva ekologije, prostornog planiranja i podnijetog zahtjeva Agencije za izgradnju i razvoj Podgorice, d.o.o. Podgorica, izdaje:	
<b>URBANISTIČKO-TEHNIČKE USLOVE</b>	
<b>za izradu tehničke dokumentacije -</b>	
<b>za izradu Glavnog projekta saobraćajnice radnog naziva "Ulica broj 20" u zahvatu DUP-a "Zabjelo 8" u Podgorici</b>	
<b>PODNOŠILAC ZAHTJEVA:</b>	<b>Agencija za izgradnju i razvoj Podgorice, d.o.o. Podgorica</b>
<b>1</b>	<b>POSTOJEĆE STANJE</b>
	Uvidom u priloženu dokumentaciju i planske smjernice može se konstatovati da saobraćajnica nije izgrađena shodno smjericama plana.
<b>2</b>	<b>PLANIRANO STANJE</b>
<b>2.1.</b>	<b>Namjena parcele odnosno lokacije</b>



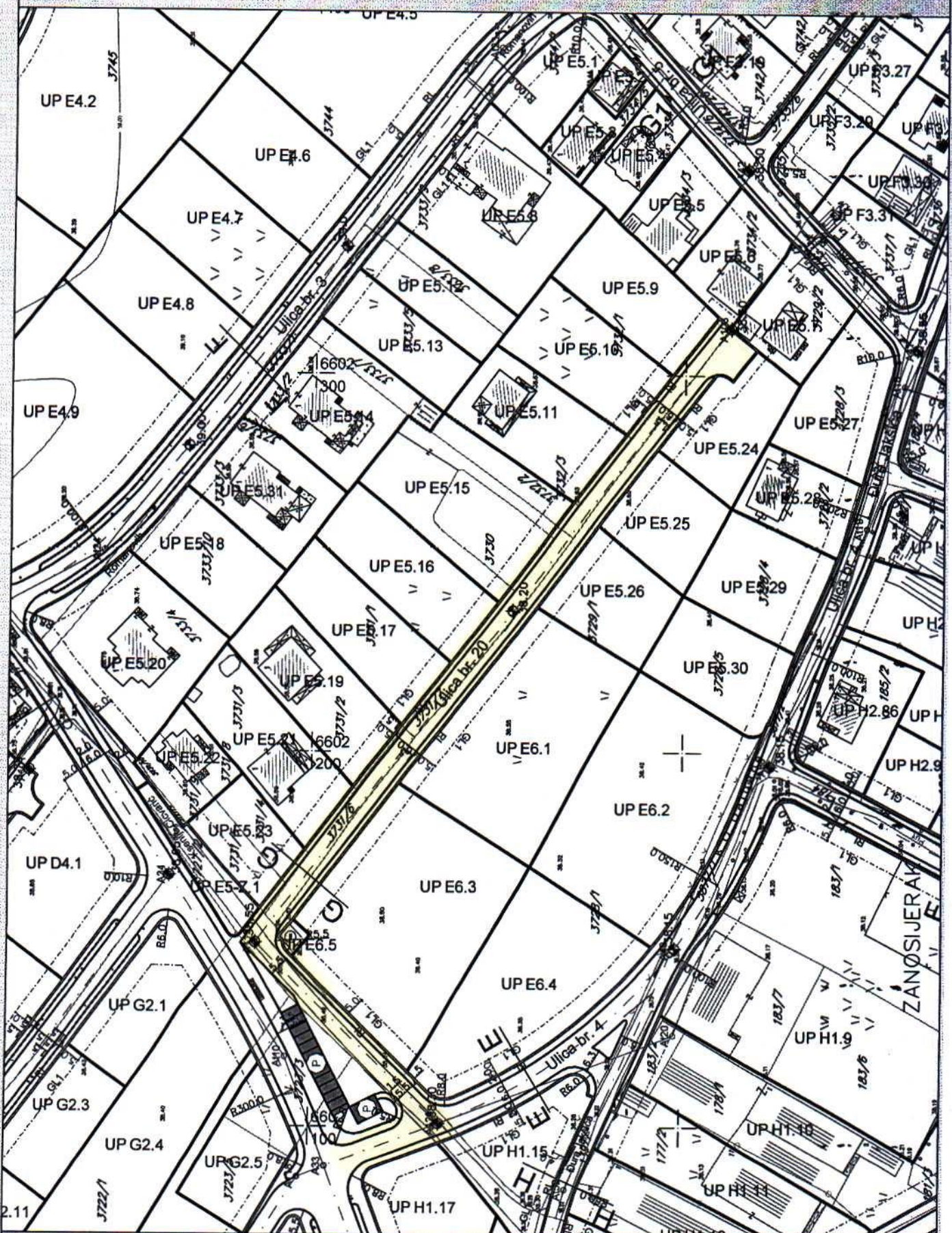



G G

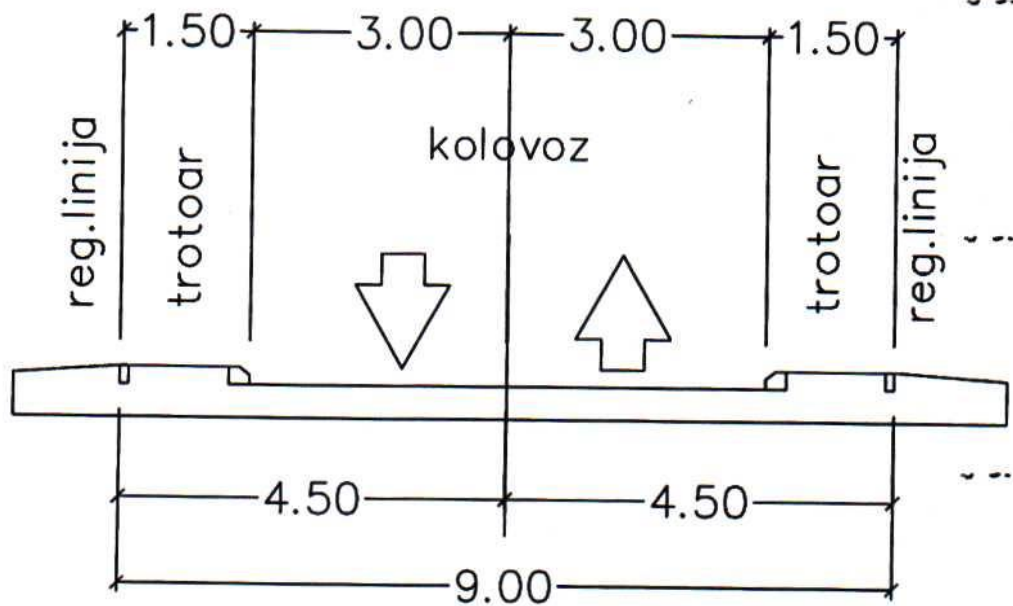



KOORDINATE TEMENA SAOBRAĆAJNICA		
br.	Y	X
At1	6602692.49	4698436.72
At2	6602844.93	4698836.57
At3	6602841.80	4698851.56
At4	6602001.45	4698862.12
At5	6601937.12	4699032.36
At6	6602201.99	4699143.15
At7	6602297.47	4699212.63
At8	6602576.91	4699269.11
At9	6602374.66	4699155.73
At10	6602118.98	4698706.66
At11	6602528.19	4699032.72
At12	6602618.17	4698518.33
At13	6602478.73	4698310.14
At14	6602350.05	4698275.00
At15	6602520.60	4698248.24
At16	6602553.06	4698415.89
At17	6602351.85	4698522.21
At18	6602297.61	4698541.12
At19	6602259.81	4698551.14
At20	6602125.06	4698601.96
At21	6602540.69	4698488.28
At22	6602455.18	4698561.08
At23	6602386.24	4698650.79
At24	6602253.15	4698756.52
At25	6602237.82	4698786.10
At26	6602207.43	4698816.12
At27	6602138.94	4698900.28
At28	6602081.95	4699005.39
At29	6602566.52	4698674.13
At30	6602522.60	4698720.91
At31	6602441.13	4698768.94
At32	6602388.92	4698783.46
At33	6602669.67	4698663.07
At34	6602562.25	4698797.33
At35	6602459.00	4698839.56
At36	6602367.22	4698895.19
At37	6602265.11	4699035.47
At38	6602454.56	4699026.18
At39	6602639.00	4699033.35
At40	6602748.61	4698927.02
At41	6602691.98	4698887.21
At42	6602664.74	4698855.88
At43	6602574.22	4698793.01
At44	6602614.15	4699238.12
At45	6602713.90	4699166.47
At46	6602501.02	4699128.22
At47	6602511.87	4699091.85
At48	6602093.34	4698853.55
At49	6601973.57	4698977.67
At50	6602016.38	4698859.82
At51	6602069.89	4698810.16
At52	6602083.12	4698630.73
At53	6602157.13	4698498.54
At54	6602203.18	4698465.10
At55	6602188.36	4698387.59
At56	6602520.95	4698602.65
At57	6602585.05	4698336.06
At58	6602658.42	4698351.21
At59	6602749.99	4698709.84
At60	6602724.01	4698728.31
At61	6602237.74	4698182.67
At62	6602260.72	4698508.73

KOORDINATE TAČAKA SAOBRAĆAJNICA		
br.	Y	X
A1	6601833.77	4698986.89
A2	6601919.01	4698819.35
A3	6601919.75	4698817.90
A4	6601996.39	4698667.27
A5	6602719.94	4698261.70
A6	6602719.70	4698263.18
A7	6602702.84	4698373.31
A8	6602702.54	4698432.43
A9	6602729.19	4698532.98
A10	6602751.92	4698592.60
A11	6602767.62	4698633.79
A12	6602790.70	4698694.33
A13	6602812.60	4698751.71
A14	6602868.54	4698857.28
A15	6602941.13	4698795.70
A16	6602797.42	4699067.34
A17	6602762.98	4699234.90
A18	6602683.11	4699218.56
A19	6602661.59	4699355.57
A20	6602607.31	4699332.24
A21	6602622.07	4699206.17
A22	6602608.95	4699286.80
A23	6602584.99	4699198.60
A24	6602136.66	4698908.90
A25	6602491.30	4699175.81
A26	6602411.00	4699147.57
A27	6602252.15	4699063.77
A28	6602227.27	4699159.85
A29	6602107.51	4698958.37
A30	6602063.05	4699084.83
A31	6601962.86	4699042.97
A32	6602007.44	4698884.44
A33	6602089.21	4698695.38
A34	6602167.02	4698738.39
A35	6602236.48	4698786.24
A36	6602310.03	4698848.40
A37	6602494.53	4698998.50
A38	6602495.52	4698999.07
A39	6602550.93	4699025.81
A40	6602635.64	4699046.54
A41	6602307.17	4698537.79
A42	6602354.63	4698583.80
A43	6602403.31	4698628.57
A44	6602508.59	4698729.87
A45	6602565.52	4698784.27
A46	6602641.66	4698839.97
A47	6602675.41	4698868.55
A48	6602057.05	4698637.80
A49	6602146.76	4698602.92
A50	6602196.33	4698576.61
A51	6602224.43	4698443.95
A52	6602275.64	4698546.95
A53	6602225.17	4698357.52
A54	6602305.53	4698449.31
A55	6602276.09	4698323.32
A56	6602377.76	4698508.47
A57	6602428.27	4698481.83
A58	6602448.55	4698259.56
A59	6602523.11	4698373.28
A60	6602474.73	4698457.28
A61	6602455.38	4698467.52
A62	6602624.58	4698298.66

A63	6602625.12	4698298.13
A64	6602653.17	4698270.41
A65	6602677.52	4698387.62
A66	6602527.62	4698429.37
A67	6602554.57	4698455.85
A68	6602561.61	4698462.89
A69	6602590.43	4698491.08
A70	6602543.15	4698532.62
A71	6602542.20	4698593.52
A72	6602467.44	4698550.93
A73	6602493.58	4698576.19
A74	6602462.99	4698655.38
A75	6602663.59	4698559.20
A76	6602583.06	4698654.55
A77	6602598.04	4698668.42
A78	6602565.41	4698675.09
A79	6602579.67	4698688.93
A80	6602535.16	4698707.54
A81	6602509.28	4698683.60
A82	6602719.57	4698609.59
A83	6602722.25	4698612.00
A84	6602753.74	4698640.34
A85	6602708.46	4698734.10
A86	6602750.85	4698733.80
A87	6602443.37	4698849.67
A88	6602548.38	4698827.56
A89	6602670.88	4698884.01
A90	6602628.66	4698961.04
A91	6602388.91	4698898.15
A92	6602321.02	4698958.66
A93	6602524.88	4699073.28
A94	6602627.99	4699067.02
A95	6602610.16	4699121.55
A96	6602563.81	4699107.58
A97	6602719.33	4699123.19
A98	6602720.46	4699114.16
A99	6602715.03	4699148.92
A100	6602241.02	4698988.38
A101	6602194.48	4698776.18
A102	6602016.74	4698747.74
A103	6602312.58	4698587.87
A104	6602429.99	4698527.49
A105	6602352.30	4698462.50
A106	6602380.84	4698340.64
A107	6602435.47	4698388.12
A108	6602634.04	4698469.20
A109	6602687.25	4698466.75
A110	6602178.20	4698852.81
A111	6602727.01	4699196.77
A112	6602735.70	4699154.20
A113	6602740.35	4699131.39
A114	6602244.14	4698898.52
A115	6602603.60	4698980.11
A116	6602512.44	4698920.38
A117	6602530.39	4698841.67
A118	6602086.36	4698702.79
A119	6602149.51	4698715.03
A120	6602100.89	4698664.95
A121	6602327.77	4698403.13
A122	6602372.34	4698384.76
A123	6602597.20	4698256.69
A124	6602679.46	4698443.48
A125	6602610.49	4698510.70
A126	6602572.82	4698567.39
A127	6602713.74	4698748.68
A128	6602283.86	4698459.21
A129	6602443.12	4698849.42
A130	6602147.84	4698892.32
A131	6601992.80	4698666.93





## LEGENDA:



Postojeća trafostanica



Postojeći elektrovod 10kV



Postojeći elektrovod 35kV



Postojeći elektrovod 10kV koji se ukida



Postojeći elektrovod 35kV koji se ukida



Planirana trafostanica



Planirani elektrovod 10kV



Planirani elektrovod 35kV



Granica traforeona

TR 6

Oznaka traforeona



Zona zaštite dalekovoda



granica DUP-a



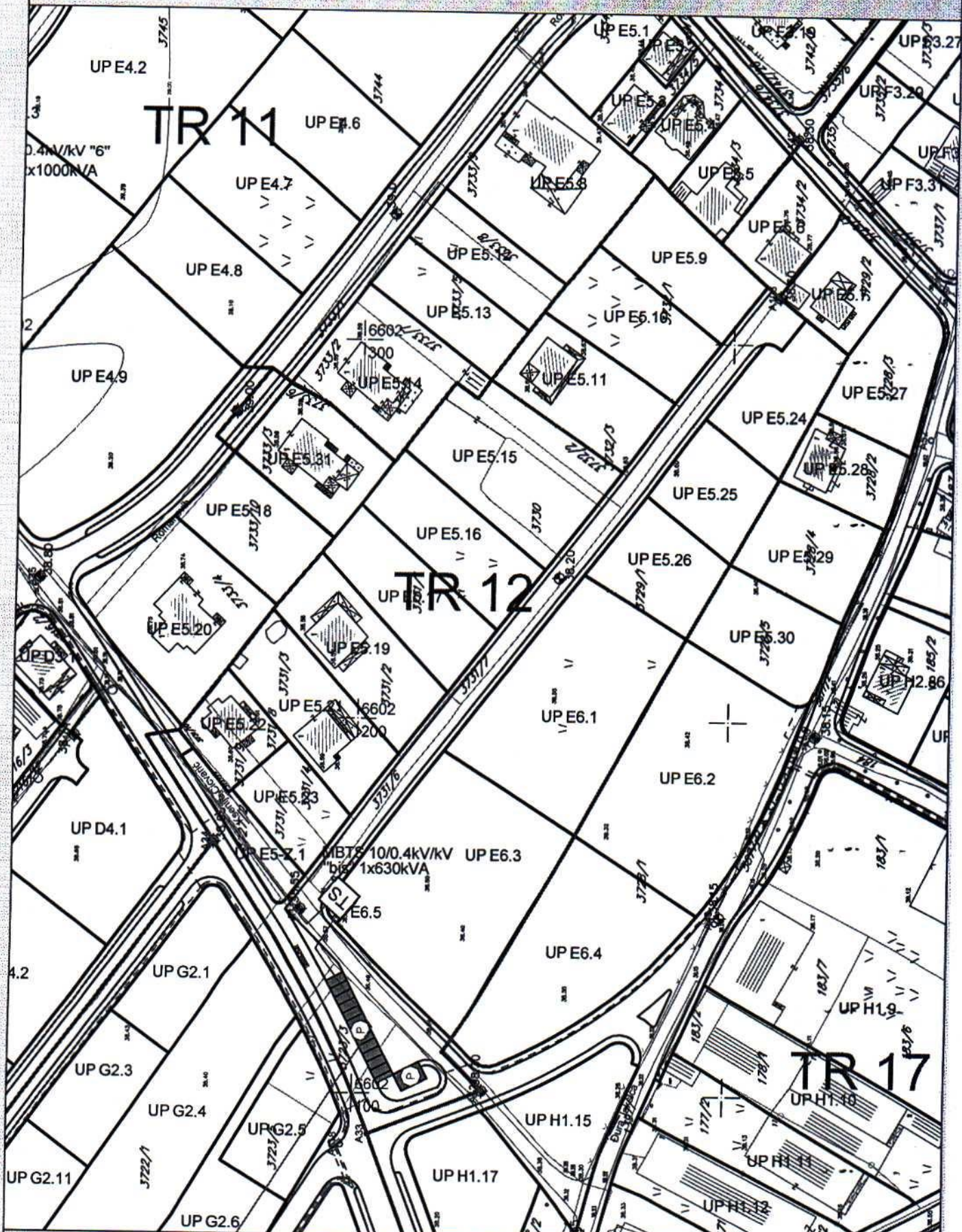





## LEGENDA:

	Postojeći vodovod
	Planirani vodovod
	Ukidanje vodovoda
	Planirani vodovod višeg reda
	Postojeći kanalizacioni vod
	Planirani kanalizacioni vod
	Planirani kanalizacioni vod višeg reda
	Smer odvođenja kanalizacionih vodova
	Postojeća atmosferska kanalizacija
	Planirana atmosferska kanalizacija
	Smer odvođenja atmosferske kanalizacije
	granica DUP-a



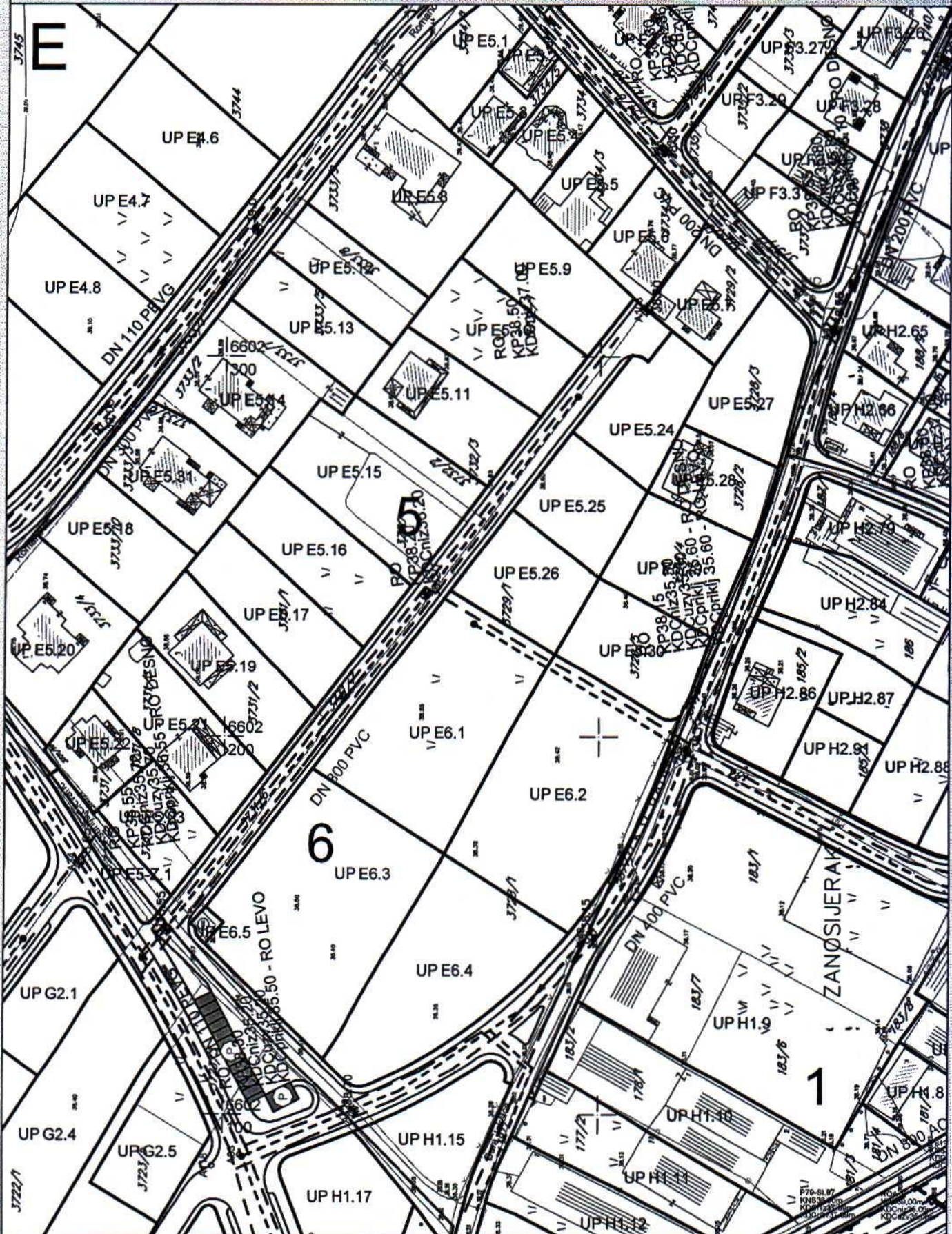



CRNA GORA  
GLAVNI GRAD- PODGORICA  
Sekretarijat za planiranje  
prostora i održivi razvoj  
Broj: 08-332/23-1716

DUP "Zabjelo 8" Podgorica

Podnosilac zahtjeva:  
Agencija za izgradnju i razvoj Podgorice

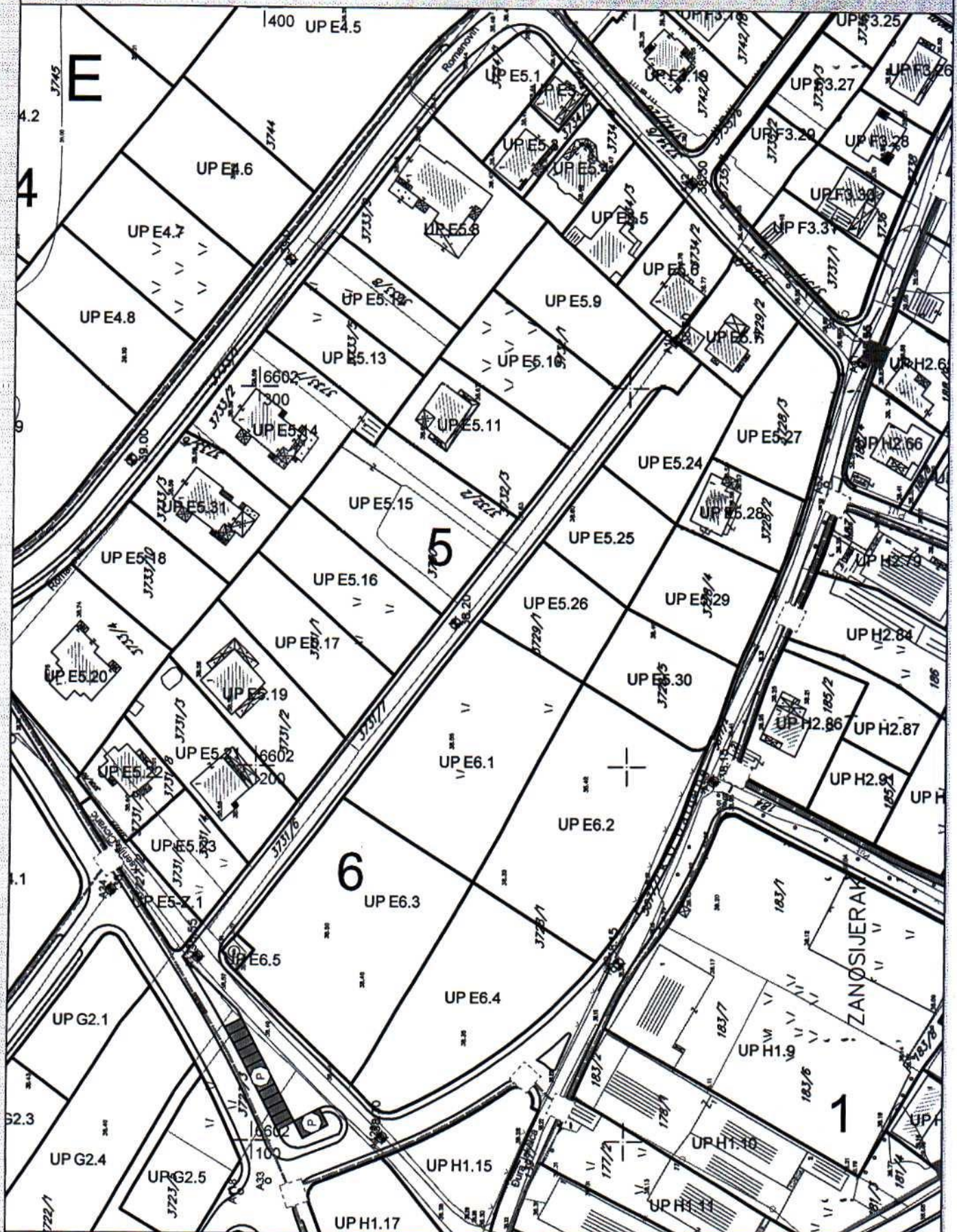





## LEGENDA:



Postojeće TK okno



Postojeći TK vod



Postojeći TK vod višeg reda



Planirano TK okno



Planirani TK vod

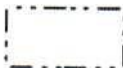

granica DUP-a





## LEGENDA:

### DRUMSKI SAOBRAĆAJ



Ulice u naselju (kolovoz, trotoari i parkinzi)



Javni parking

### PARCELACIJA



Granica urbanističke parcele



Građevinska linija GL1



Građevinska linija-privremena (do ukidanja dalekovoda)



Regulaciona linija

UP B3.4

Oznaka urbanističke parcele

UP B3-7 2

Oznaka urbanističke parcele zelenih površina

3

Oznaka urbanističkog bloka

D

Oznaka urbanističke zone



Zona zaštite dalekovoda



Saobraćajnica u zahvatu DUP-a "Zabjelo 8" u Podgorici, koja je predmet UTU –a, markirana je na graf. prilogu "Saobraćaj".

Saobraćajnica pripada mreži sekundarnih ulica. Sekundarni dio mreže predložen je tako da, dopunjujući primarni sistem mreže, obezbjeđuje pristupačnost do svake parcele.

#### **Urbanističko-tehnički uslovi za saobraćajne površine**

Saobraćajno rješenje na području plana je zasnovano na koncepciji saobraćajnog rješenja i smjernicama koje su date u PUP-u za isti prostor i na analizi postojećeg stanja saobraćajne mreže. Prema PUP-u glavnog grada Podgorica planirane su gradske ulice.

Gradske ulice – sabirne planirane su tako da širina kolovoza bude 6 – 7m, sa dvostranim trotoarima, a gdje god je bilo moguće planirane su i zelene površine.

Gradske ulice – pristupne planirane su tako da širina kolovoza bude minimum 5 metara i gdje god je moguće planirani su trotoari.

Širina pješačke staze kombinovana sa saobraćajem je data u karakterističnom poprečnom profilu odgovarajuće saobraćajnice.

Poprečni profil i osovina predmetne saobraćajnice prikazani su na grafičkom prilogu "Saobraćaj".

Trase novih saobraćajnica su prilagođene terenu, a priključci kotama izvedenih saobraćajnica. Nivelacione kote su date na karakterističnim i ukrsnim tačkama i služe kao orijentacija prilikom izrade Idejnih i Glavnih projekata, pri čemu su poštovani propisi. Zastori kolskih saobraćajnica planirani su od asfalta, kolsko-pješačke i pješačke staze i trotoari od asfalta, kamena, betona i njihovih elemenata.

PUP-om su predloženi poprečni profili koji su usklađeni sa važećim planskim dokumentima. Data je mogućnost korekcije profila prilikom izrade projektne dokumentacije u cilju utvrđivanja najracionalnijeg poprečnog profila i ukupnog tehničkog rješenja koje je moguće izvesti na predmetnoj trasi.

Tip raskrsnice može se promijeniti projektnim rješenjem ako se nakon analize uslova na terenu i sagledavanja saobraćajnih rješenja u kontaktnim zonama i protoka vozila pokaže da je bolje neko drugo rješenje raskrsnice.

Vertikalno rješenje – niveletu saobraćajnica raditi na osnovu visinskih kota koje su date u grafičkom prilogu a služe kao orijentacija pri izradi glavnih projekata. Zato je potrebno za novoprojektovane saobraćajnice gde duž njih nema izgrađenih objekata a predviđeni su planom, prvo uraditi glavne projekte ulica a zatim tačnije odrediti kote niveleta koje su u planu takođe date orijentaciono. Na dijelovima gdje nema dovoljno visinskih kota potrebno je pre izrade glavnih projekata snimiti teren i projektovati niveletu.

-Vertikalna zaobljenja nivelete izvesti u zavisnosti od ranga saobraćajnice, odnosno računске brzine.

-Nivelacione elemente smatrati orijentacionim, a pri njihovom utvrđivanju (na nivou izvođačkih projekata) izbjegavati primjenu nultih nagiba, odnosno obezbjeđiti gravitaciono odvođenje atmosferskih voda.

-Nivelaciju novih pješačkih i biciklističkih površina izvesti na istoj nivelacionoj koti sa potrebom zadovoljavanja efikasnog odvodnjavanja atmosferskih voda.

-Odvodnjavanje atmosferskih voda izvršiti putem slivnika i cjevovoda do kanalizacije, a izbor slivnika uskladiti sa obradom površine na kojoj se nalazi (kolovoz ili pješačka staza).







# KOORDINATE TAČAKA PARCELACIJE

br.	Y	X
1	6602377.19	4698342.77
2	6602377.89	4698343.63
3	6602376.25	4698349.10
4	6602375.39	4698349.61
5	6602674.38	4699237.48
6	6602675.63	4699230.11
7	6602676.68	4699226.73
8	6602673.61	4699223.82
9	6602720.30	4698604.19
10	6602725.77	4698604.61
11	6602742.35	4698593.78
12	6602743.51	4698590.20
13	6602739.97	4698580.91
14	6602642.07	4699140.90
15	6602645.95	4699141.30
16	6602653.44	4699128.53
17	6602457.19	4698356.05
18	6602442.70	4698325.11
19	6602461.48	4698352.68
20	6602414.10	4698290.06
21	6602417.27	4698287.76
22	6602425.75	4698300.21
23	6602596.10	4698670.52
24	6602595.09	4698671.48
25	6602593.88	4698672.95
26	6602593.18	4698673.68
27	6602588.10	4698679.33
28	6602580.78	4698686.21
29	6602580.07	4698685.52
30	6602579.75	4698685.90
31	6602575.18	4698681.84
32	6602575.67	4698681.25
33	6602572.99	4698678.65
34	6602573.34	4698678.29
35	6602572.99	4698673.36
36	6602574.76	4698671.29
37	6602581.86	4698662.89
38	6602586.91	4698662.58
39	6602587.25	4698662.21
40	6602580.90	4698687.66
41	6602581.57	4698686.98
42	6602578.43	4698690.21
43	6602649.71	4698633.19
44	6602660.87	4698631.07
45	6602700.51	4698552.06
46	6602713.43	4698574.17
47	6602443.68	4698407.65
48	6602411.22	4698400.75
49	6602414.60	4698450.43
50	6602417.56	4698455.15
51	6602417.72	4698455.08
52	6602418.19	4698454.90
53	6602427.77	4698471.52
54	6602433.10	4698473.06
55	6602447.53	4698465.43
56	6602447.49	4698462.47
57	6602412.38	4698444.81
58	6602411.55	4698445.29
59	6602386.23	4698399.43
60	6602387.56	4698401.75
61	6602387.14	4698402.01
62	6602386.77	4698402.23
63	6602391.80	4698411.05
64	6602392.20	4698410.80
65	6602392.63	4698410.54
66	6602392.91	4698411.04
67	6602374.88	4698380.74
68	6602380.56	4698390.59
69	6602380.98	4698390.34
70	6602383.15	4698394.16
71	6602384.78	4698397.03
72	6602384.83	4698397.00
73	6602374.19	4698379.53
74	6602365.60	4698362.90
75	6602372.34	4698374.17
76	6602374.24	4698378.00
77	6602374.19	4698379.40
78	6602358.42	4698351.08
79	6602359.31	4698352.45

br.	Y	X
81	6602339.58	4698362.79
82	6602327.70	4698344.36
83	6602332.65	4698351.75
84	6602323.34	4698337.84
85	6602321.52	4698334.93
86	6602623.58	4699343.43
87	6602616.50	4699340.37
88	6602606.32	4699336.21
89	6602606.59	4699335.13
90	6602632.77	4699362.76
91	6602647.65	4699370.83
92	6602653.22	4699373.85
93	6602655.68	4699375.11
94	6602657.85	4699361.33
95	6602656.93	4699361.19
96	6602655.17	4699356.92
97	6602651.06	4699355.22
98	6602642.82	4699351.66
99	6602632.87	4699347.42
100	6602627.45	4699359.95
101	6602586.86	4699339.40
102	6602607.15	4699349.25
103	6602095.51	4698665.10
104	6602095.67	4698664.58
105	6602113.85	4698630.59
106	6602108.98	4698624.61
107	6602108.18	4698622.78
108	6602088.27	4698631.48
109	6602079.57	4698634.54
110	6602074.29	4698635.97
111	6602028.59	4698628.86
112	6602047.25	4698591.99
113	6602041.82	4698602.93
114	6602210.51	4698449.86
115	6602215.42	4698445.12
116	6602215.99	4698440.10
117	6602216.83	4698439.56
118	6602200.56	4698414.13
119	6602195.04	4698406.25
120	6602194.70	4698405.80
121	6602190.84	4698399.83
122	6602190.46	4698400.07
123	6602189.07	4698398.14
124	6602186.88	4698386.68
125	6602187.08	4698385.94
126	6602186.56	4698385.13
127	6602182.21	4698389.28
128	6602178.83	4698394.14
129	6602201.18	4698458.41
130	6602201.41	4698458.21
131	6602202.54	4698457.22
132	6602203.66	4698456.24
133	6602204.77	4698455.24
134	6602206.24	4698453.90
135	6602200.66	4698458.86
136	6602199.14	4698460.17
137	6602196.85	4698462.10
138	6602194.00	4698464.45
139	6602194.95	4698465.78
140	6602192.87	4698467.21
141	6602175.76	4698478.99
142	6602170.98	4698482.57
143	6602170.68	4698482.17
144	6602240.09	4698650.11
145	6602256.96	4698700.05
146	6602229.02	4698647.32
147	6602148.61	4698607.85
148	6602193.05	4698583.06
149	6602114.74	4698673.12
150	6602109.26	4698667.80
151	6602107.96	4698661.05
152	6602145.63	4698704.94
153	6602155.39	4698704.73
154	6602154.19	4698705.67
155	6602154.27	4698705.79
156	6602151.00	4698708.61
157	6602150.02	4698707.62
158	6602146.91	4698706.26
159	6602191.60	4698676.50

br.	Y	X
161	6602606.63	4699286.67
162	6602613.17	4699287.24
163	6602613.12	4699287.24
164	6602617.89	4699245.18
165	6602616.56	4699255.57
166	6602640.30	4699217.03
167	6602640.30	4699216.90
168	6602630.68	4699214.95
169	6602623.08	4699219.75
170	6602622.39	4699222.55
171	6602621.22	4699227.47
172	6602655.52	4699220.13
173	6602655.56	4699219.91
174	6602647.17	4699218.20
175	6602647.12	4699218.42
176	6602644.34	4699217.85
177	6602671.63	4699257.06
178	6602671.73	4699257.08
179	6602672.22	4699257.19
180	6602672.98	4699252.38
181	6602672.07	4699252.24
182	6602673.62	4699242.42
183	6602673.98	4699239.95
184	6602674.10	4699239.21
185	6602644.01	4699277.00
186	6602647.12	4699251.65
187	6602666.67	4699287.06
188	6602680.79	4699168.14
189	6602678.25	4699173.30
190	6602681.79	4699175.05
191	6602658.68	4699089.86
192	6602647.67	4699107.39
193	6602666.77	4699286.35
194	6602667.61	4699286.48
195	6602670.09	4699270.75
196	6602669.49	4699270.65
197	6602662.37	4699316.41
198	6602662.81	4699313.73
199	6602663.58	4699308.84
200	6602663.11	4699308.66
201	6602663.49	4699306.26
202	6602663.96	4699306.45
203	6602665.00	4699299.83
204	6602643.32	4699342.44
205	6602646.24	4699343.70
206	6602653.67	4699346.78
207	6602657.95	4699344.50
208	6602659.81	4699331.92
209	6602627.00	4699335.45
210	6602636.55	4699339.52
211	6602608.45	4699327.54
212	6602619.93	4699332.38
213	6602649.23	4699311.98
214	6602646.96	4699323.69
215	6602606.67	4699286.50
216	6602607.15	4699282.55
217	6602607.64	4699278.93
218	6602661.13	4699221.27
219	6602658.20	4699235.68
220	6602605.39	4699297.19
221	6602603.91	4699306.30
222	6602603.79	4699307.01
223	6602593.37	4699304.11
224	6602613.12	4699287.26
225	6602615.56	4699264.88
226	6602636.61	4699307.72
227	6602613.86	4699300.05
228	6602611.54	4699311.86
229	6602608.35	4699328.07
230	6602589.08	4699327.39
231	6602625.92	4699334.98
232	6602629.45	4699316.87
233	6602631.56	4699306.02
234	6602643.98	4699277.22
235	6602641.50	4699276.14
236	6602639.90	4699250.05
237	6602618.22	4699245.26
238	6602642.87	4699232.28
239	6602641.46	4699231.97

br.	Y	X
241	6602721.71	4698723.75
242	6602719.51	4698724.88
243	6602719.73	4698725.45
244	6602717.79	4698726.19
245	6602717.64	4698725.79
246	6602710.19	4698728.92
247	6602706.42	4698730.33
248	6602706.69	4698731.06
249	6602704.42	4698731.90
250	6602704.67	4698732.58
251	6602753.73	4698649.39
252	6602771.31	4698664.81
253	6602771.39	4698668.65
254	6602773.63	4698674.53
255	6602776.33	4698677.70
256	6602780.57	4698688.80
257	6602777.96	4698694.61
258	6602760.42	4698701.31
259	6602737.10	4698713.78
260	6602732.28	4698717.22
261	6602714.39	4698649.57
262	6602750.81	4698646.83
263	6602732.15	4698628.38
264	6602712.17	4698602.82
265	6602731.04	4699027.54
266	6602743.50	4699018.34
267	6602790.68	4699024.40
268	6602784.38	4699055.03
269	6602777.74	4699059.77
270	6602714.68	4699051.66
271	6602803.90	4698960.14
272	6602835.22	4698829.83
273	6602845.09	4698850.90
274	6602844.39	4698864.39
275	6602832.02	4698884.44
276	6602750.79	4698742.43
277	6602749.91	4698740.00
278	6602751.33	4698736.83
279	6602751.87	4698736.61
280	6602745.31	4698718.48
281	6602763.45	4698709.26
282	6602781.00	4698702.55
283	6602786.80	4698705.15
284	6602829.08	4698816.05
285	6602833.73	4698



# KOORDINATE TAČAKA PARCELACIJE

br.	Y	X
321	6602661.57	4698348.39
322	6602647.82	4698326.10
323	6602654.07	4698336.28
324	6602654.10	4698336.34
325	6602081.69	4698734.76
326	6602102.45	4698722.69
327	6602111.03	4698717.79
328	6602117.26	4698713.48
329	6602094.61	4698702.92
330	6602091.55	4698704.75
331	6602080.38	4698711.43
332	6602120.74	4698715.31
333	6602154.18	4698740.73
334	6602154.05	4698735.81
335	6602144.06	4698729.22
336	6602105.21	4698776.92
337	6602121.72	4698764.71
338	6602068.69	4698804.13
339	6602075.43	4698798.92
340	6602016.65	4698739.30
341	6602015.70	4698737.82
342	6602020.35	4698734.81
343	6602024.58	4698737.62
344	6602046.08	4698723.74
345	6602622.02	4699165.07
346	6602609.57	4699197.74
347	6602620.78	4699164.66
348	6602662.40	4699131.32
349	6602669.80	4699119.74
350	6602679.87	4699104.01
351	6602680.60	4699102.87
352	6602655.37	4699129.66
353	6602661.25	4699133.11
354	6602603.57	4699172.82
355	6602698.34	4699183.22
356	6602703.19	4699116.43
357	6602709.40	4699120.15
358	6602709.14	4699120.58
359	6602712.75	4699122.74
360	6602714.42	4699126.18
361	6602713.56	4699133.01
362	6602700.62	4699114.88
363	6602659.04	4699089.52
364	6602673.82	4699098.81
365	6602644.09	4699080.13
366	6602599.12	4699171.41
367	6602636.76	4699152.79
368	6602635.15	4699157.65
369	6602639.82	4699159.14
370	6602638.45	4699162.87
371	6602619.79	4699146.32
372	6602452.83	4699123.63
373	6602474.68	4699133.03
374	6602474.68	4699109.21
375	6602474.67	4699110.69
376	6602474.63	4699117.92
377	6602474.96	4699124.36
378	6602474.75	4699107.83
379	6602476.88	4699095.61
380	6602481.37	4699084.19
381	6602485.34	4699075.23
382	6602484.78	4699076.61
383	6602491.18	4699062.29
384	6602488.87	4699066.67
385	6602488.56	4699067.35
386	6602486.49	4699072.42
387	6602475.32	4699160.76
388	6602474.33	4699151.91
389	6602474.32	4699142.07
390	6602474.56	4699137.03
391	6602654.51	4699206.86
392	6602656.68	4699201.17
393	6602670.14	4699210.97
394	6602674.76	4699174.94
395	6602682.03	4699179.01
396	6602667.71	4699172.34
397	6602656.28	4699162.62
398	6602657.14	4699161.31
399	6602653.38	4699167.06
400	6602652.04	4699169.10

br.	Y	X
401	6602650.73	4699172.67
402	6602643.22	4699193.09
403	6602641.24	4699198.18
404	6602635.48	4699154.84
405	6602527.88	4699156.12
406	6602519.69	4699156.77
407	6602551.16	4699128.68
408	6602543.04	4699142.23
409	6602539.67	4699147.84
410	6602638.91	4699118.64
411	6602642.96	4699113.44
412	6602681.24	4699181.06
413	6602683.02	4699181.77
414	6602684.54	4699178.01
415	6602720.17	4699191.51
416	6602722.16	4699191.94
417	6602724.47	4699195.48
418	6602724.32	4699196.22
419	6602729.70	4699197.33
420	6602729.83	4699196.71
421	6602733.40	4699194.38
422	6602735.81	4699194.90
423	6602723.11	4699177.12
424	6602721.95	4699182.82
425	6602717.48	4699158.72
426	6602722.31	4699155.94
427	6602727.18	4699157.19
428	6602768.01	4699134.60
429	6602748.45	4699133.04
430	6602732.76	4699129.84
431	6602730.13	4699142.72
432	6602735.03	4699143.72
433	6602734.78	4699144.94
434	6602728.62	4699148.78
435	6602729.00	4699147.33
436	6602724.33	4699146.14
437	6602721.38	4699141.58
438	6602722.49	4699134.13
439	6602723.93	4699122.67
440	6602738.72	4699125.98
441	6602738.28	4699127.93
442	6602749.00	4699130.34
443	6602676.43	4699094.54
444	6602659.60	4699083.97
445	6602717.76	4699062.14
446	6602737.28	4699064.65
447	6602774.82	4699069.48
448	6602779.93	4699076.64
449	6602769.02	4699129.71
450	6602704.46	4699074.34
451	6602715.83	4699063.91
452	6602682.70	4699096.20
453	6602691.55	4699087.10
454	6602697.00	4699081.50
455	6602680.99	4699060.41
456	6602676.10	4699064.94
457	6602660.99	4699081.85
458	6602454.16	4699092.25
459	6602475.05	4699102.26
460	6602457.32	4699093.76
461	6602457.71	4699088.40
462	6602456.12	4699087.64
463	6602459.28	4699089.16
464	6602757.42	4699173.68
465	6602740.84	4699170.30
466	6602284.73	4699019.57
467	6602301.03	4698997.16
468	6602341.05	4698942.19
469	6602354.74	4698923.38
470	6602386.74	4698919.76
471	6602382.83	4698916.45
472	6602382.81	4698916.27
473	6602380.67	4698914.54
474	6602380.58	4698914.55
475	6602373.57	4698908.63
476	6602366.72	4698909.00
477	6602358.81	4698918.05
478	6602310.39	4699092.97
479	6602402.39	4699138.06
480	6602410.36	4699134.55

br.	Y	X
481	6602441.19	4699048.64
482	6602472.80	4699007.47
483	6602478.06	4699003.83
484	6602477.97	4698993.91
485	6602446.11	4698969.92
486	6602410.20	4698939.58
487	6602710.69	4699177.93
488	6602707.91	4699159.34
489	6602690.13	4699149.22
490	6602708.20	4698742.34
491	6602693.40	4698839.42
492	6602688.00	4698844.24
493	6602684.19	4698848.11
494	6602680.87	4698850.74
495	6602674.00	4698857.05
496	6602671.03	4698773.34
497	6602679.85	4698795.83
498	6602683.27	4698806.06
499	6602645.79	4698700.92
500	6602646.39	4698702.48
501	6602656.93	4698729.83
502	6602655.00	4698731.55
503	6602658.91	4698741.92
504	6602660.12	4698745.11
505	6602665.19	4698758.22
506	6602181.39	4698634.47
507	6602202.29	4698623.14
508	6602114.98	4698673.36
509	6602121.84	4698668.88
510	6602134.93	4698661.67
511	6602166.26	4698642.92
512	6602169.46	4698641.13
513	6602283.04	4698709.41
514	6602288.10	4698719.91
515	6602258.44	4698698.83
516	6602268.15	4698691.22
517	6602247.88	4698707.53
518	6602289.73	4698665.43
519	6602314.70	4698698.37
520	6602314.99	4698698.75
521	6602286.93	4698667.53
522	6602284.77	4698669.00
523	6602288.83	4698674.94
524	6602284.70	4698678.12
525	6602271.38	4698688.62
526	6602294.65	4698661.72
527	6602302.75	4698655.49
528	6602312.82	4698647.76
529	6602310.69	4698649.40
530	6602308.00	4698651.46
531	6602340.40	4698678.81
532	6602371.96	4698654.05
533	6602372.49	4698653.64
534	6602388.96	4698637.00
535	6602393.31	4698631.34
536	6602392.73	4698624.61
537	6602386.58	4698618.96
538	6602327.81	4698688.68
539	6602290.22	4698718.18
540	6602265.22	4698738.60
541	6602270.08	4698734.63
542	6602197.14	4698747.14
543	6602204.12	4698753.14
544	6602214.74	4698762.69
545	6602222.24	4698769.00
546	6602225.32	4698771.19
547	6602231.03	4698775.45
548	6602237.06	4698774.04
549	6602253.09	4698750.21
550	6602151.64	4698719.08
551	6602151.77	4698722.32
552	6602189.27	4698747.10
553	6602174.01	4698701.63
554	6602207.12	4698675.82
555	6602190.61	4698688.69
556	6602223.80	4698662.80
557	6602266.00	4698629.90
558	6602299.93	4698603.45
559	6602280.27	4698607.36
560	6602300.33	4698591.72

br.	Y	X
561	6602299.27	4698588.03
562	6602298.69	4698587.29
563	6602306.97	4698580.84
564	6602260.03	4698623.14
565	6602242.53	4698636.79
566	6602222.83	4698574.43
567	6602207.94	4698576.63
568	6602208.14	4698577.19
569	6602205.88	4698577.99
570	6602252.09	4698558.99
571	6602247.15	4698561.08
572	6602230.49	4698568.42
573	6602226.73	4698569.98
574	6602309.63	4698546.19
575	6602300.98	4698544.17
576	6602294.94	4698545.97
577	6602275.91	4698551.01
578	6602335.41	4698571.65
579	6602318.29	4698554.75
580	6602343.21	4698579.08
581	6602335.70	4698571.93
582	6602350.43	4698585.72
583	6602375.94	4698609.18
584	6602206.66	4698739.67
585	6602204.55	4698741.32
586	6602197.29	4698747.02
587	6602212.86	4698735.22
588	6602193.76	4698718.70
589	6602244.09	4698710.65
590	6602240.44	4698713.66
591	6602229.00	4698723.24
592	6602229.83	4698722.55
593	6602228.73	4698723.44
594	6602252.30	4698559.46
595	6602242.17	4698600.24
596	6602107.28	4698605.55
597	6602095.83	4698586.91
598	6602080.77	4698561.31
599	6602079.96	4698559.93
600		



KOORDINATE TAČKA PARCELACIJE

br.	Y	X
641	6602091.19	4698536.54
642	6602106.00	4698562.23
643	6602126.44	4698598.39
644	6602091.63	4698513.41
645	6602168.63	4698723.40
646	6602158.32	4698713.87
647	6602271.12	4698552.35
648	6602261.46	4698589.21
649	6602264.70	4698567.40
650	6602180.17	4698533.36
651	6602226.86	4698560.18
652	6602219.86	4698562.93
653	6602202.04	4698569.15
654	6602197.14	4698567.17
655	6602234.60	4698556.77
656	6602243.52	4698552.85
657	6602259.61	4698516.85
658	6602268.47	4698539.77
659	6602267.61	4698544.00
660	6602249.41	4698496.70
661	6602253.74	4698504.43
662	6602244.54	4698488.02
663	6602210.65	4698463.67
664	6602217.17	4698460.98
665	6602227.21	4698457.13
666	6602198.32	4698473.95
667	6602206.20	4698467.64
668	6601908.88	4698870.14
669	6601906.46	4698873.92
670	6601903.91	4698877.17
671	6601899.71	4698883.74
672	6601852.40	4698976.55
673	6601856.39	4698987.50
674	6601914.17	4698859.74
675	6601973.42	4698961.32
676	6601954.00	46989030.52
677	6601959.56	4699027.51
678	6601964.88	4698995.13
679	6601971.19	4698968.15
680	6602677.27	4698565.47
681	6602696.89	4698583.12
682	6602697.65	4698583.80
683	6602723.84	4698538.60
684	6602733.29	4698563.40
685	6602680.85	4698446.14
686	6602694.61	4698439.55
687	6602696.21	4698439.21
688	6602699.30	4698459.98
689	6602690.84	4698464.01
690	6602686.88	4698466.10
691	6602686.10	4698464.71
692	6602685.20	4698465.22
693	6602679.72	4698463.60
694	6602679.24	4698462.70
695	6602674.89	4698465.19
696	6602640.86	4698468.79
697	6602635.52	4698471.82
698	6602668.50	4698453.14
699	6602649.69	4698484.80
700	6602675.31	4698470.13
701	6602675.57	4698466.48
702	6602611.17	4698505.28
703	6602614.99	4698504.67
704	6602629.05	4698496.62
705	6602602.45	4698496.58
706	6602605.72	4698499.79
707	6602597.68	4698491.89
708	6602603.69	4698433.78
709	6602567.16	4698453.80
710	6602566.17	4698460.95
711	6602628.77	4698420.05
712	6602628.82	4698420.02
713	6602694.61	4698389.01
714	6602689.40	4698385.79
715	6602629.04	4698288.29
716	6602622.10	4698287.54
717	6602609.76	4698268.63
718	6602480.97	4698259.17
719	6602462.88	4698261.40
720	6602460.92	4698262.12

br.	Y	X
721	6602460.99	4698262.62
722	6602459.70	4698268.62
723	6602557.20	4698257.16
724	6602560.09	4698257.32
725	6602616.69	4698300.48
726	6602617.30	4698294.82
727	6602599.79	4698267.98
728	6602585.95	4698259.47
729	6602586.58	4698328.92
730	6602602.02	4698314.86
731	6602604.88	4698312.16
732	6602606.55	4698310.51
733	6602577.77	4698335.48
734	6602512.42	4698349.43
735	6602522.48	4698363.74
736	6602527.82	4698364.86
737	6602529.28	4698363.98
738	6602529.57	4698364.45
739	6602495.52	4698325.39
740	6602484.92	4698309.77
741	6602491.75	4698319.96
742	6602464.47	4698276.61
743	6602471.63	4698288.58
744	6602326.48	4698393.32
745	6602334.11	4698395.79
746	6602338.41	4698394.15
747	6602323.08	4698304.46
748	6602320.02	4698303.22
749	6602314.15	4698306.98
750	6602314.19	4698307.04
751	6602323.96	4698338.77
752	6602336.38	4698331.24
753	6602337.60	4698325.55
754	6602336.41	4698323.81
755	6602044.78	4698905.19
756	6602038.05	4698847.53
757	6602015.76	4698878.92
758	6602017.37	4698884.94
759	6602072.23	4698816.11
760	6602065.64	4698821.95
761	6602082.27	4698808.17
762	6602183.04	4698779.58
763	6602182.13	4698776.50
764	6602181.22	4698775.31
765	6602185.19	4698772.27
766	6602186.10	4698773.46
767	6602192.41	4698774.30
768	6602192.81	4698774.00
769	6602195.18	4698777.10
770	6602198.84	4698774.23
771	6602204.82	4698769.35
772	6602171.93	4698747.62
773	6602163.91	4698747.84
774	6602138.97	4698766.27
775	6602161.17	4698796.31
776	6602098.56	4698844.20
777	6602128.72	4698821.13
778	6602112.32	4698872.27
779	6602098.88	4698862.71
780	6602094.05	4698853.21
781	6602218.11	4698731.45
782	6602551.17	4698859.43
783	6602547.02	4698855.08
784	6602538.11	4698845.76
785	6602538.64	4698838.37
786	6602604.62	4698820.83
787	6602626.39	4698835.95
788	6602626.18	4698844.30
789	6602607.44	4698855.96
790	6602579.18	4698803.02
791	6602582.46	4698805.36
792	6602585.75	4698807.69
793	6602589.04	4698809.99
794	6602592.33	4698812.29
795	6602595.62	4698814.57
796	6602559.42	4698797.21
797	6602571.34	4698797.26
798	6602575.91	4698800.65
799	6602504.67	4698827.90
800	6602520.07	4698820.87

br.	Y	X
801	6602490.53	4698833.68
802	6602478.48	4698879.52
803	6602454.48	4698854.96
804	6602455.22	4698850.21
805	6602473.85	4698840.96
806	6602531.13	4698837.86
807	6602546.64	4698825.74
808	6602534.04	4698835.59
809	6602562.47	4698813.35
810	6602577.36	4698801.70
811	6602550.12	4698829.38
812	6602585.17	4698834.87
813	6602567.54	4698847.60
814	6602326.20	4698637.14
815	6602011.79	4698755.16
816	6602018.60	4698750.61
817	6602070.88	4698716.98
818	6602066.27	4698719.68
819	6602058.08	4698724.36
820	6602043.86	4698733.50
821	6602037.76	4698737.44
822	6602026.53	4698745.30
823	6602489.67	4698638.06
824	6602501.75	4698650.31
825	6602512.17	4698666.95
826	6602512.76	4698666.30
827	6602513.24	4698665.77
828	6602521.92	4698656.12
829	6602500.29	4698654.93
830	6602485.84	4698640.33
831	6602333.30	4698504.99
832	6602313.34	4698471.35
833	6602321.27	4698484.12
834	6602311.31	4698468.11
835	6602299.84	4698454.66
836	6602303.44	4698455.54
837	6602304.94	4698457.99
838	6602277.02	4698455.37
839	6602281.47	4698463.06
840	6602254.87	4698416.98
841	6602243.39	4698397.09
842	6602208.55	4698376.22
843	6602208.70	4698376.10
844	6602208.50	4698375.83
845	6602214.22	4698371.59
846	6602219.79	4698367.05
847	6602221.32	4698365.80
848	6602225.81	4698366.63
849	6602232.87	4698378.87
850	6602199.32	4698397.36
851	6602198.07	4698395.49
852	6602198.19	4698395.41
853	6602201.19	4698382.23
854	6602227.08	4698440.73
855	6602211.82	4698416.89
856	6602211.00	4698415.60
857	6602208.09	4698411.06
858	6602287.26	4698513.15
859	6602268.51	4698524.63
860	6602264.73	4698514.86
861	6602260.28	4698504.96
862	6602291.79	4698479.15
863	6602288.54	4698473.92
864	6602286.14	4698469.94
865	6602294.91	4698484.14
866	6602292.83	4698480.81
867	6602292.31	4698479.98
868	6602286.08	4698489.45
869	6602296.59	4698507.44
870	6602292.54	4698500.51
871	6602292.39	4698500.25
872	6602291.76	4698499.17
873	6602291.53	4698498.78
874	6602288.00	4698492.74
875	6602287.56	4698491.98
876	6602287.24	4698491.44
877	6602299.91	4698536.09
878	6602292.89	4698538.24
879	6602299.99	4698541.66
880	6602275.23	4698539.23

br.	Y	X
881	6602274.30	4698539.59
882	6602269.66	4698527.61
883	6602288.91	4698515.89
884	6602302.00	4698535.36
885	6602329.12	4698525.91
886	6602369.84	4698500.96
887	6602370.44	4698502.04
888	6602368.40	4698508.94
889	6602342.46	4698520.89
890	6602338.33	4698453.53
891	6602345.73	4698449.25
892	6602349.64	4698455.97
893	6602349.88	4698456.42
894	6602352.54	4698462.28
895	6602349.38	4698464.03
896	6602323.34	4698411.41
897	6602326.19	4698415.65
898	6602336.98	4698434.20
899	6601999.96	4698955.45
900	6601996.53	4698967.21
901	6601994.14	4698973.35
902	6601993.13	4698976.52
903	6601988.08	4698974.51
904	6602001.47	4698950.25
905	6602008.08	4698930.76
906	6602008.06	4698930.82
907	6602006.32	4698935.94
908	6601980.94	4698975.78
909	6601983.44	4698974.41
910	6601987.72	4698975.90
911	6601976.23	4698996.79
912	6601979.57	4698980.92
913	6602001.21	4699049.67
914	6601974.11	4699038.47
915	6601970.48	4699031.95
916	6602070.84	4699026.79
917	6602067.52	4699039.05
918	6602060.29	4699069.43
919	6602054.85	4699072.19
920	660207	



# KOORDINATE TAČAKA PARCELACIJE

br.	Y	X
961	6602483.51	4698699.30
962	6602497.25	4698683.53
963	6602490.01	4698666.47
964	6602491.04	4698665.46
965	6602493.81	4698668.35
966	6602492.70	4698669.44
967	6602492.63	4698674.35
968	6602499.23	4698681.26
969	6602472.98	4698652.03
970	6602474.23	4698655.11
971	6602485.03	4698666.40
972	6602487.57	4698667.48
973	6602489.26	4698637.22
974	6602503.13	4698624.61
975	6602489.69	4698636.84
976	6602516.01	4698612.90
977	6602530.04	4698604.43
978	6602529.15	4698603.57
979	6602528.96	4698603.38
980	6602527.76	4698602.21
981	6602542.06	4698593.59
982	6602530.78	4698603.76
983	6602556.41	4698585.34
984	6602575.60	4698574.88
985	6602569.25	4698574.38
986	6602574.11	4698564.67
987	6602579.78	4698571.31
988	6602578.46	4698572.44
989	6602551.69	4698530.78
990	6602550.35	4698533.34
991	6602549.27	4698534.30
992	6602550.52	4698537.02
993	6602559.98	4698548.11
994	6602599.41	4698506.21
995	6602593.05	4698499.98
996	6602586.93	4698499.81
997	6602578.21	4698507.47
998	6602578.03	4698507.27
999	6602573.01	4698511.71
1000	6602573.17	4698511.90
1001	6602654.49	4698562.94
1002	6602654.07	4698556.69
1003	6602651.88	4698554.72
1004	6602631.42	4698536.30
1005	6602626.94	4698595.57
1006	6602635.07	4698585.93
1007	6602642.29	4698577.39
1008	6602623.49	4698599.65
1009	6602623.42	4698598.96
1010	6602625.78	4698596.16
1011	6602626.47	4698596.12
1012	6602610.15	4698615.44
1013	6602582.17	4698648.56
1014	6602559.49	4698674.92
1015	6602567.88	4698665.48
1016	6602569.25	4698663.86
1017	6602530.74	4698699.08
1018	6602531.08	4698698.72
1019	6602537.42	4698698.49
1020	6602552.29	4698682.61
1021	6602511.43	4698681.25
1022	6602507.03	4698686.03
1023	6602493.78	4698709.72
1024	6602506.36	4698721.83
1025	6602511.91	4698722.38
1026	6602514.88	4698720.48
1027	6602523.55	4698713.28
1028	6602526.13	4698710.53
1029	6602525.91	4698704.15
1030	6602526.24	4698703.78
1031	6602511.45	4698690.12
1032	6602483.25	4698699.59
1033	6602472.55	4698689.29
1034	6602471.85	4698656.96
1035	6602469.06	4698655.60
1036	6602452.85	4698670.34
1037	6602488.17	4698674.03
1038	6602722.99	4698619.57
1039	6602720.92	4698617.58

br.	Y	X
1041	6602604.09	4698564.02
1042	6602603.83	4698563.74
1043	6602605.00	4698562.55
1044	6602602.25	4698559.79
1045	6602601.24	4698560.83
1046	6602590.81	4698549.60
1047	6602586.52	4698581.62
1048	6602586.74	4698581.36
1049	6602587.41	4698582.01
1050	6602589.99	4698578.98
1051	6602598.32	4698570.14
1052	6602483.40	4698542.63
1053	6602478.03	4698547.21
1054	6602477.37	4698547.77
1055	6602477.17	4698554.42
1056	6602490.73	4698567.53
1057	6602496.83	4698567.67
1058	6602523.98	4698508.09
1059	6602515.40	4698515.39
1060	6602537.17	4698496.56
1061	6602529.99	4698502.97
1062	6602580.74	4698493.93
1063	6602580.90	4698488.07
1064	6602565.29	4698472.79
1065	6602558.67	4698473.14
1066	6602555.21	4698477.34
1067	6602548.74	4698484.81
1068	6602542.63	4698527.42
1069	6602513.81	4698522.75
1070	6602502.50	4698562.68
1071	6602433.98	4698388.97
1072	6602437.64	4698386.89
1073	6602437.89	4698387.32
1074	6602444.02	4698389.02
1075	6602444.46	4698388.77
1076	6602429.51	4698381.08
1077	6602420.34	4698365.41
1078	6602419.03	4698363.49
1079	6602346.60	4698332.91
1080	6602344.89	4698329.96
1081	6602346.83	4698332.77
1082	6602364.13	4698285.88
1083	6602333.99	4698297.87
1084	6602327.99	4698300.54
1085	6602328.25	4698305.79
1086	6602391.24	4698276.97
1087	6602387.21	4698278.19
1088	6602436.72	4698292.69
1089	6602422.42	4698271.73
1090	6602419.54	4698269.48
1091	6602401.42	4698274.07
1092	6602472.79	4698309.45
1093	6602487.34	4698331.14
1094	6602500.06	4698349.23
1095	6602509.92	4698363.26
1096	6602529.40	4698391.22
1097	6602524.86	4698384.51
1098	6602518.40	4698375.32
1099	6602529.62	4698421.69
1100	6602530.79	4698420.92
1101	6602535.97	4698415.18
1102	6602537.34	4698406.00
1103	6602535.76	4698401.77
1104	6602530.05	4698392.23
1105	6602516.43	4698429.58
1106	6602495.05	4698440.34
1107	6602513.55	4698430.58
1108	6602473.06	4698449.28
1109	6602474.76	4698451.05
1110	6602445.13	4698394.56
1111	6602444.80	4698399.50
1112	6602447.10	4698393.42
1113	6602452.04	4698368.80
1114	6602457.04	4698378.08
1115	6602408.24	4698301.31
1116	6602425.43	4698326.10
1117	6602442.84	4698350.46
1118	6602441.48	4698351.26
1119	6602442.24	4698352.44

br.	Y	X
1121	6602309.98	4698456.62
1122	6602305.40	4698458.71
1123	6602269.27	4698425.92
1124	6602283.92	4698451.31
1125	6602288.41	4698452.74
1126	6602290.66	4698451.71
1127	6602298.30	4698448.21
1128	6602297.88	4698446.37
1129	6602297.01	4698444.95
1130	6602301.59	4698442.86
1131	6602244.14	4698348.47
1132	6602240.44	4698351.12
1133	6602237.59	4698353.23
1134	6602233.91	4698355.97
1135	6602232.63	4698362.43
1136	6602244.70	4698383.35
1137	6602276.67	4698332.03
1138	6602271.19	4698330.82
1139	6602266.82	4698333.55
1140	6602260.61	4698337.55
1141	6602254.24	4698341.72
1142	6602250.84	4698343.95
1143	6602247.91	4698345.88
1144	6602296.32	4698362.39
1145	6602326.48	4698408.95
1146	6602317.44	4698394.99
1147	6602357.20	4698396.60
1148	6602372.44	4698393.53
1149	6602367.03	4698391.54
1150	6602381.86	4698409.87
1151	6602417.62	4698481.24
1152	6602419.21	4698475.71
1153	6602419.65	4698475.46
1154	6602406.78	4698453.13
1155	6602392.01	4698494.77
1156	6602376.25	4698499.11
1157	6602377.58	4698498.41
1158	6602382.32	4698499.89
1159	6602390.53	4698495.56
1160	6602347.65	4698446.97
1161	6602352.33	4698454.83
1162	6602356.13	4698462.80
1163	6602120.15	4698519.58
1164	6602113.15	4698509.25
1165	6602110.63	4698505.71
1166	6602606.67	4698749.81
1167	6602580.24	4698778.13
1168	6602580.71	4698790.30
1169	6602586.42	4698794.62
1170	6602589.52	4698796.88
1171	6602592.08	4698798.69
1172	6602595.34	4698800.97
1173	6602598.61	4698803.26
1174	6602601.89	4698805.54
1175	6602631.05	4698825.79
1176	6602635.16	4698828.64
1177	6602639.27	4698831.52
1178	6602643.39	4698834.44
1179	6602647.49	4698837.40
1180	6602651.56	4698840.41
1181	6602655.61	4698843.50
1182	6602659.61	4698846.67
1183	6602665.07	4698851.21
1184	6602661.71	4698861.03
1185	6602700.75	4698639.85
1186	6602699.21	4698638.75
1187	6602686.29	4698652.59
1188	6602705.51	4698643.24
1189	6602803.76	4698960.81
1190	6602746.43	4699009.96
1191	6602753.03	4699005.09
1192	6602754.34	4699004.13
1193	6602779.88	4698983.62
1194	6602782.46	4698980.70
1195	6602791.87	4698970.57
1196	6602803.10	4698960.22
1197	6602790.16	4698951.95
1198	6602775.64	4698941.73
1199	6602766.69	4698934.49

br.	Y	X
1201	6602416.87	4698771.28
1202	6602369.78	4698804.72
1203	6602320.96	4698844.91
1204	6602320.92	4698854.05
1205	6602432.47	4698775.76
1206	6602402.30	4698784.15
1207	6602381.81	4698794.82
1208	6602452.05	4698767.54
1209	6602492.30	4698744.25
1210	6602527.71	4698802.29
1211	6602552.65	4698786.05
1212	6602553.04	4698778.34
1213	6602545.35	4698771.13
1214	6602506.25	4698813.10
1215	6602499.75	4698815.86
1216	6602485.61	4698821.65
1217	6602434.97	4698846.60
1218	6602462.31	4698832.04
1219	6602402.27	4698866.34
1220	6602413.34	4698859.63
1221	6602427.49	4698851.05
1222	6602428.77	4698859.28
1223	6602352.01	4698877.33
1224	6602364.15	4698887.58
1225	6602370.58	4698887.60
1226	6602389.63	4698874.00
1227	6602518.86	4698790.82
1228	6602521.40	4698794.06
1229	6602523.56	4698796.81
1230	6602499.83	4698765.89
1231	6602504.38	4698774.71
1232	6602513.62	4698784.17
1233	6602519.08	4698751.92
1234	6602517.26	4698753.09
1235	6602512.68	4698756.01
1236	6602507.46	4698760.16
1237	6602505.70	469874



# KOORDINATE TAČAKA PARCELACIJE

br.	Y	X
1281	6602594.95	4698332.12
1282	6602610.50	4698317.85
1283	6602607.41	4698320.78
1284	6602634.19	4698320.59
1285	6602627.05	4698309.20
1286	6602620.07	4698308.39
1287	6602651.79	4698348.64
1288	6602651.74	4698348.57
1289	6602644.13	4698336.43
1290	6602657.34	4698358.31
1291	6602668.04	4698388.09
1292	6602669.81	4698382.08
1293	6602659.06	4698361.58
1294	6602624.63	4698412.62
1295	6602648.02	4698399.41
1296	6602577.04	4698438.69
1297	6602661.86	4698332.23
1298	6602663.92	4698335.08
1299	6602656.61	4698340.34
1300	6602693.86	4698306.18
1301	6602655.65	4698289.89
1302	6602659.46	4698295.64
1303	6602667.54	4698291.11
1304	6602661.38	4698305.50
1305	6602656.94	4698298.48
1306	6602646.61	4698282.86
1307	6602672.53	4698318.97
1308	6602670.87	4698320.48
1309	6602687.80	4698344.39
1310	6602679.14	4698329.86
1311	6602674.92	4698322.90
1312	6602700.05	4698338.41
1313	6602687.10	4698310.00
1314	6602544.79	4698284.75
1315	6602563.04	4698269.33
1316	6602556.68	4698257.54
1317	6602582.88	4698332.00
1318	6602582.71	4698331.77
1319	6602582.10	4698330.94
1320	6602564.73	4698309.13
1321	6602599.00	4698364.26
1322	6602604.11	4698361.18
1323	6602602.85	4698344.75
1324	6602610.62	4698357.26
1325	6602566.33	4698264.89
1326	6602578.63	4698279.98
1327	6602586.59	4698287.93
1328	6602613.94	4698314.45
1329	6602622.24	4698327.89
1330	6602630.27	4698344.77
1331	6602631.93	4698343.59
1332	6602607.10	4698321.06
1333	6602607.19	4698326.61
1334	6602607.88	4698331.81
1335	6602609.08	4698335.07
1336	6602610.73	4698336.92
1337	6602614.94	4698339.11
1338	6602616.64	4698341.14
1339	6602619.17	4698346.36
1340	6602673.81	4698286.26
1341	6602668.05	4698276.57
1342	6602665.01	4698271.55
1343	6602662.40	4698267.26
1344	6602389.47	4698848.19
1345	6602419.67	4698826.00
1346	6602396.37	4698885.12
1347	6602440.51	4698858.36
1348	6602446.68	4698859.14
1349	6602382.04	4698902.69
1350	6602382.18	4698894.94
1351	6602389.33	4698889.67
1352	6602452.56	4698962.28
1353	6602467.28	4698888.39
1354	6602437.07	4698912.38
1355	6602415.14	4698930.66
1356	6602480.15	4698717.01
1357	6602492.11	4698734.55
1358	6602492.04	4698728.84
1359	6602651.69	4698677.55
1360	6602635.44	4698697.85

br.	Y	X
1361	6602610.89	4698728.53
1362	6602598.45	4698744.08
1363	6602598.87	4698743.56
1364	6602577.32	4698767.15
1365	6602588.52	4698755.66
1366	6602551.24	4698765.01
1367	6602562.39	4698775.33
1368	6602568.34	4698775.36
1369	6602534.56	4698714.70
1370	6602530.11	4698719.44
1371	6602520.35	4698727.66
1372	6602519.70	4698734.66
1373	6602530.83	4698745.37
1374	6602538.39	4698710.62
1375	6602577.73	4698690.92
1376	6602569.35	4698682.78
1377	6602569.00	4698683.14
1378	6602564.01	4698683.26
1379	6602563.03	4698707.98
1380	6602566.65	4698703.76
1381	6602569.48	4698700.94
1382	6602570.94	4698699.37
1383	6602573.04	4698697.12
1384	6602577.18	4698692.69
1385	6602578.11	4698691.28
1386	6602551.47	4698696.65
1387	6602552.86	4698698.29
1388	6602556.99	4698702.28
1389	6602041.15	4698844.66
1390	6602097.15	4698845.48
1391	6602106.11	4698790.55
1392	6602059.54	4698804.33
1393	6602066.46	4699024.88
1394	6602015.25	4698745.43
1395	6602022.27	4698779.33
1396	6602149.27	4698879.56
1397	6602146.49	4698880.01
1398	6602170.80	4698851.84
1399	6602167.11	4698856.37
1400	6602182.66	4698837.32
1401	6602225.44	4698792.35
1402	6602222.91	4698794.88
1403	6602216.93	4698798.11
1404	6602183.85	4698835.81
1405	6602196.85	4698779.72
1406	6602200.41	4698777.00
1407	6602206.63	4698771.88
1408	6602208.08	4698771.51
1409	6602210.78	4698773.29
1410	6602224.87	4698783.33
1411	6602227.15	4698789.02
1412	6602142.10	4698821.60
1413	6602119.85	4698862.44
1414	6602117.49	4698865.52
1415	6602115.05	4698863.78
1416	6602105.08	4698849.93
1417	6602105.34	4698849.72
1418	6602123.82	4698835.38
1419	6602134.38	4698854.50
1420	6602121.13	4698861.72
1421	6602120.94	4698861.83
1422	6602045.25	4698890.49
1423	6602030.89	4698899.57
1424	6602410.69	4698311.80
1425	6602170.36	4698832.04
1426	6602155.95	4698811.28
1427	6602155.83	4698811.10
1428	6602170.50	4698831.94
1429	6602193.35	4698813.02
1430	6602187.85	4698818.73
1431	6602184.79	4698821.83
1432	6602181.35	4698824.03
1433	6602179.44	4698825.42
1434	6602206.38	4698802.82
1435	6602199.43	4698807.13
1436	6602196.24	4698810.02
1437	6602218.21	4698795.49
1438	6602215.13	4698797.39
1439	6601946.36	4698874.16
1440	6601926.46	4698863.47

br.	Y	X
1441	6601920.40	4698860.31
1442	6601916.20	4698857.65
1443	6601915.34	4698857.28
1444	6602496.44	4698732.05
1445	6602497.30	4698724.91
1446	6602484.67	4698712.75
1447	6602486.33	4698737.88
1448	6602455.44	4698755.76
1449	6602431.28	4698767.26
1450	6602447.80	4698760.18
1451	6602430.20	4698767.57
1452	6602360.28	4698801.53
1453	6602376.41	4698788.26
1454	6602400.03	4698775.96
1455	6602354.80	4698806.04
1456	6602373.75	4698811.20
1457	6602306.83	4698839.15
1458	6602314.52	4698839.20
1459	6602292.12	4698732.76
1460	6602273.12	4698748.28
1461	6602249.70	4698776.78
1462	6602246.80	4698782.22
1463	6602248.22	4698789.63
1464	6602249.65	4698790.84
1465	6602298.13	4698727.86
1466	6602331.49	4698701.69
1467	6602409.26	4698640.20
1468	6602401.83	4698640.76
1469	6602398.87	4698644.62
1470	6602380.20	4698663.47
1471	6602351.52	4698685.97
1472	6602452.63	4698681.92
1473	6602459.60	4698688.63
1474	6602469.47	4698698.13
1475	6602448.12	4698795.20
1476	6602442.34	4698784.53
1477	6602436.89	4698776.07
1478	6602436.67	4698775.73
1479	6602436.01	4698774.69
1480	6602464.25	4698791.52
1481	6602458.91	4698795.79
1482	6602451.93	4698800.73
1483	6602474.41	4698784.11
1484	6602471.79	4698786.02
1485	6602467.19	4698758.78
1486	6602480.50	4698778.70
1487	6602478.25	4698742.55
1488	6602466.43	4698729.95
1489	6602444.46	4698738.21
1490	6602461.44	4698723.55
1491	6602431.11	4698766.99
1492	6602423.67	4698756.57
1493	6602212.93	4698989.05
1494	6602197.24	4699012.90
1495	6602194.48	4699015.78
1496	6602260.84	4698993.42
1497	6602217.57	4698965.18
1498	6602238.52	4698981.13
1499	6602241.78	4698979.21
1500	6602241.93	4698979.01
1501	6602243.39	4698980.13
1502	6602179.46	4698936.15
1503	6602161.72	4698922.64
1504	6602177.65	4698934.77
1505	6602145.51	4698906.75
1506	6602146.18	4698910.81
1507	6602159.89	4698921.25
1508	6602182.88	4698861.25
1509	6602178.85	4698861.82
1510	6602161.92	4698863.52
1511	6602156.95	4698890.31
1512	6602217.35	4698885.13
1513	6602199.01	4698872.43
1514	6602241.62	4698901.95
1515	6602283.10	4698934.39
1516	6602311.69	4698960.43
1517	6602311.12	4698956.30
1518	6602297.64	4698945.76
1519	6602278.11	4699006.57
1520	6602295.81	4698982.25

br.	Y	X
1521	6602274.22	4699011.91
1522	6602122.87	4698962.88
1523	6602219.79	4698977.55
1524	6602204.89	4698966.21
1525	6602188.98	4698954.09
1526	6602232.16	4698991.69
1527	6602232.29	4698991.51
1528	6602233.30	4698987.84
1529	6602245.91	4698982.05
1530	6602236.14	4698994.72
1531	6602226.44	4699001.64
1532	6602215.74	4699015.13
1533	6602233.42	4698992.64
1534	6602227.58	4699000.21
1535	6602723.28	4698656.72
1536	6602687.57	4698669.56
1537	6602674.09	4698674.46
1538	6602664.07	4698678.10
1539	6602599.21	4698667.16
1540	6602596.83	4698669.72
1541	6602596.15	4698670.46
1542	6602602.83	4698638.06
1543	6602590.58	4698652.56
1544	6602590.87	4698657.39
1545	6602590.53	4698657.76
1546	6602599.89	4698666.42
1547	6602599.37	4698666.98
1548	6602618.64	4698619.34
1549	6602667.45	4698568.74
1550	6602661.00	4698569.18
1551	6602687.80	4698586.87
1552	6602712.77	4698610.29
1553	6602712.79	4698609.54</



# KOORDINATE TAČAKA PARCELACIJE

br.	Y	X
1601	6602431.77	4698529.60
1602	6602375.76	4698563.92
1603	6602343.19	4698567.37
1604	6602353.30	4698576.73
1605	6602358.34	4698576.94
1606	6602320.22	4698538.27
1607	6602320.20	4698544.69
1608	6602341.38	4698565.60
1609	6602351.27	4698527.01
1610	6602335.27	4698533.27
1611	6602374.22	4698576.05
1612	6602421.99	4698490.81
1613	6602454.03	4698473.87
1614	6602500.83	4698449.14
1615	6602508.85	4698444.90
1616	6602504.19	4698447.37
1617	6602540.27	4698448.11
1618	6602529.15	4698437.18
1619	6602528.79	4698437.55
1620	6602524.10	4698436.85
1621	6602542.46	4698479.09
1622	6602548.65	4698471.94
1623	6602553.07	4698466.57
1624	6602552.82	4698460.44
1625	6602534.35	4698487.49
1626	6602526.51	4698494.74
1627	6602524.48	4698496.50
1628	6602496.35	4698520.44
1629	6602509.99	4698508.83
1630	6602472.52	4698540.74
1631	6602483.13	4698531.70
1632	6602467.98	4698544.69
1633	6602455.73	4698556.39
1634	6602397.54	4698617.50
1635	6602407.10	4698616.67
1636	6602435.73	4698579.41
1637	6602438.54	4698575.83
1638	6602438.47	4698573.53
1639	6602364.17	4698581.05
1640	6602364.19	4698586.83
1641	6602391.12	4698611.59
1642	6602392.77	4698559.67
1643	6602502.47	4698613.72
1644	6602478.85	4698588.59
1645	6602483.69	4698584.04
1646	6602486.20	4698581.88
1647	6602489.97	4698578.62
1648	6602454.52	4698557.63
1649	6602442.79	4698567.19
1650	6602417.66	4698587.91
1651	6602427.15	4698580.12
1652	6602430.11	4698577.62
1653	6602398.03	4698605.85
1654	6602396.95	4698604.81
1655	6602405.37	4698597.99
1656	6602395.12	4698549.45
1657	6602401.69	4698524.56
1658	6602380.16	4698569.35
1659	6602380.02	4698569.20
1660	6602460.49	4698605.70
1661	6602465.74	4698600.92
1662	6602463.54	4698602.99
1663	6602452.52	4698639.41
1664	6602446.52	4698618.16
1665	6602438.81	4698624.85
1666	6602452.35	4698612.96
1667	6602521.55	4698582.82
1668	6602544.14	4698595.81
1669	6602543.68	4698595.32
1670	6602539.57	4698590.51
1671	6602542.14	4698593.52
1672	6602547.72	4698583.55
1673	6602564.72	4698564.45
1674	6602564.33	4698569.38
1675	6602518.80	4698559.68
1676	6602539.67	4698541.34
1677	6602545.35	4698541.75
1678	6602554.75	4698552.76
1679	6602508.87	4698568.40
1680	6602513.80	4698589.82

br.	Y	X
1681	6602503.36	4698579.73
1682	6602503.51	4698573.11
1683	6602527.17	4698602.74
1684	6602628.03	4698659.35
1685	6602631.78	4698603.78
1686	6602410.05	4698485.24
1687	6602409.43	4698484.25
1688	6602409.29	4698483.98
1689	6602399.26	4698465.16
1690	6602395.72	4698459.30
1691	6602371.97	4698457.72
1692	6602365.01	4698460.57
1693	6602356.78	4698463.96
1694	6602376.21	4698465.51
1695	6602502.26	4698451.38
1696	6602509.91	4698471.30
1697	6602512.23	4698469.54
1698	6602504.45	4698475.36
1699	6602491.08	4698454.30
1700	6602501.06	4698477.84
1701	6602489.63	4698486.20
1702	6602436.60	4698484.21
1703	6602436.05	4698483.37
1704	6602431.55	4698507.67
1705	6602446.01	4698498.67
1706	6602402.55	4698523.98
1707	6602391.74	4698507.15
1708	6602391.57	4698506.88
1709	6602403.20	4698523.54
1710	6602407.07	4698520.93
1711	6602406.82	4698498.82
1712	6602426.90	4698506.31
1713	6602416.39	4698514.06
1714	6602419.56	4698492.09
1715	6602439.15	4698523.67
1716	6602431.89	4698512.87
1717	6602428.72	4698508.63
1718	6602445.20	4698519.18
1719	6602464.63	4698511.91
1720	6602461.14	4698507.01
1721	6602470.29	4698500.12
1722	6602454.32	4698474.34
1723	6602454.27	4698474.37
1724	6602468.12	4698496.28
1725	6602486.95	4698486.15
1726	6602482.32	4698479.63
1727	6602471.52	4698464.63
1728	6602487.90	4698487.44
1729	6602478.28	4698494.33
1730	6602475.07	4698496.66
1731	6602456.86	4698510.19
1732	6602470.51	4698499.96
1733	6602507.21	4698473.35
1734	6602517.06	4698465.88
1735	6602523.76	4698460.80
1736	6602524.98	4698459.79
1737	6602513.31	4698468.72
1738	6602438.05	4698625.51
1739	6602550.22	4698624.41
1740	6602538.68	4698637.49
1741	6602539.57	4698636.50
1742	6602527.73	4698649.66
1743	6602515.76	4698637.35
1744	6602526.64	4698650.92
1745	6602527.52	4698649.83
1746	6602478.97	4698664.41
1747	6602462.85	4698679.96
1748	6602518.83	4698688.08
1749	6602536.00	4698668.52
1750	6602501.62	4698678.51
1751	6602509.23	4698683.64
1752	6602502.51	4698677.54
1753	6602552.06	4698622.99
1754	6602551.70	4698622.59
1755	6602550.94	4698623.72
1756	6602562.00	4698611.75
1757	6602560.51	4698613.37
1758	6602570.96	4698601.26
1759	6602565.42	4698607.74
1760	6602608.79	4698615.25

br.	Y	X
1761	6602590.30	4698599.45
1762	6602588.67	4698601.37
1763	6602588.10	4698602.04
1764	6602580.76	4698595.13
1765	6602595.06	4698633.30
1766	6602577.43	4698592.31
1767	6602578.14	4698592.91
1768	6602531.48	4698573.83
1769	6602527.74	4698577.21
1770	6602535.71	4698570.00
1771	6602613.70	4698553.24
1772	6602629.96	4698534.99
1773	6602606.51	4698561.30
1774	6602619.06	4698524.99
1775	6602591.08	4698549.36
1776	6602581.50	4698530.04
1777	6602568.86	4698515.69
1778	6602577.08	4698533.75
1779	6602603.83	4698510.52
1780	6602568.11	4698505.03
1781	6602555.79	4698515.85
1782	6602534.05	4698534.96
1783	6602522.04	4698545.51
1784	6602503.18	4698525.79
1785	6602494.90	4698532.84
1786	6602599.88	4698461.41
1787	6602605.16	4698458.38
1788	6602615.14	4698452.75
1789	6602578.91	4698473.46
1790	6602629.00	4698496.50
1791	6602691.06	4698493.26
1792	6602699.18	4698507.24
1793	6602689.51	4698490.64
1794	6602674.24	4698498.93
1795	6602688.69	4698532.19
1796	6602689.93	4698534.81
1797	6602692.34	4698538.65
1798	6602696.27	4698545.08
1799	6602697.03	4698546.43
1800	6602707.76	4698521.74
1801	6602702.80	4698524.32
1802	6602695.68	4698528.03
1803	6602677.26	4698521.01
1804	6602685.90	4698533.31
1805	6602682.21	4698528.57
1806	6602680.32	4698525.69
1807	6602699.79	4698581.56
1808	6602711.64	4698576.49
1809	6602738.66	4698581.67
1810	6602733.34	4698584.78
1811	6602724.85	4698589.44
1812	6602710.75	4698575.62
1813	6602712.58	4698597.24
1814	6602720.31	4698591.71
1815	6602722.98	4698590.47
1816	6602666.21	4698613.26
1817	6602661.36	4698619.11
1818	6602692.46	4698632.06
1819	6602681.14	4698621.84
1820	6602675.61	4698617.14
1821	6602668.38	4698610.64
1822	6602657.22	4698593.18
1823	6602659.30	4698590.25
1824	6602660.44	4698588.84
1825	6602673.76	4698574.41
1826	6602586.80	4698692.85
1827	6602584.01	4698690.48
1828	6602594.58	4698698.66
1829	6602622.82	4698713.62
1830	6602622.41	4698713.28
1831	6602599.01	4698693.58
1832	6602668.95	4698609.91
1833	6602687.52	4698586.97
1834	6602679.73	4698596.36
1835	6602672.56	4698605.58
1836	6602671.80	4698606.37
1837	6602670.33	4698608.20
1838	6602643.66	4698640.48
1839	6602655.40	4698626.31
1840	6602650.52	4698632.20

br.	Y	X
1841	6602655.94	4698625.66
1842	6602656.66	4698624.79
1843	6602626.61	4698661.06
1844	6602611.42	4698677.49
1845	6602608.88	4698682.25
1846	6602606.09	4698685.41
1847	6602601.33	4698690.93
1848	6602635.38	4698697.80
1849	6602625.30	4698689.35
1850	6602612.26	4698678.41
1851	6602447.07	4698710.40
1852	6602449.94	4698713.03
1853	6602441.86	4698705.53
1854	6602434.50	4698698.66
1855	6602441.73	4698671.43
1856	6602423.34	4698688.49
1857	6602423.72	4698688.83
1858	6602682.97	4698494.19
1859	6602647.52	4698492.96
1860	6602289.25	4698928.41
1861	6602260.33	4698905.79
1862	6602246.19	4698894.77
1863	6602246.67	4698895.10
1864	6602232.31	4698885.16
1865	6602202.39	4698864.43
1866	6602217.67	4698875.01
1867	6602193.64	4698843.58
1868	6602188.04	4698850.58
1869	6602188.67	4698854.93
1870	6602241.49	4698797.03
1871	6602235.44	4698797.25
1872	6602210.90	4698822.99
1873	6602252.24	4698806.12</



# KOORDINATE TAČAKA PARCELACIJE

br.	Y	X
1921	6602298.91	4698919.23
1922	6602303.27	4698915.09
1923	6602311.86	4698906.92
1924	6602466.05	4698790.21
1925	6602299.91	4698893.36
1926	6602304.13	4698889.71
1927	6602310.24	4698884.35
1928	6602319.80	4698875.45
1929	6602325.08	4698870.23
1930	6602274.00	4698916.48
1931	6602275.69	4698914.84
1932	6602284.92	4698906.80
1933	6602295.68	4698897.01
1934	6602347.60	4698550.45
1935	6602358.13	4698556.40
1936	6602360.20	4698541.88
1937	6602361.22	4698543.46
1938	6602365.44	4698550.12
1939	6602353.81	4698559.33
1940	6602351.20	4698561.30
1941	6602531.97	4698833.41
1942	6602378.56	4698611.58
1943	6602368.05	4698620.12
1944	6602375.34	4698627.89
1945	6602547.44	4698726.44
1946	6602696.14	4698837.38
1947	6602814.59	4698834.81
1948	6602834.11	4698827.30
1949	6602711.85	4698873.88
1950	6602743.34	4698862.21
1951	6602775.68	4698849.66
1952	6602799.00	4698840.55
1953	6602802.64	4698839.37
1954	6602362.65	4698487.98
1955	6602351.99	4698468.73
1956	6602322.31	4698485.93
1957	6602325.46	4698460.99
1958	6602311.80	4698468.90
1959	6602376.37	4698542.13
1960	6602368.05	4698519.22
1961	6602373.02	4698527.66
1962	6602380.19	4698539.09
1963	6602368.95	4698547.55
1964	6602384.77	4698535.94
1965	6602385.08	4698535.73
1966	6602494.42	4698709.02
1967	6602573.43	4698723.11
1968	6602565.11	4698733.09
1969	6602566.58	4698731.41
1970	6602568.67	4698729.05
1971	6602570.90	4698726.19
1972	6602610.04	4698727.82
1973	6602586.78	4698708.37
1974	6602588.23	4698706.80
1975	6602588.97	4698706.00
1976	6602590.31	4698704.25
1977	6602592.61	4698701.48
1978	6602575.25	4698720.60
1979	6602577.54	4698718.29
1980	6602579.30	4698716.25
1981	6602581.59	4698714.00
1982	6602582.17	4698713.14
1983	6602584.97	4698710.33
1984	6602572.23	4698717.32
1985	6602563.82	4698734.62
1986	6602549.64	4698750.15
1987	6602544.14	4698755.55
1988	6602542.76	4698756.85
1989	6602483.43	4698749.38
1990	6602480.81	4698779.17
1991	6602482.28	4698778.04
1992	6602492.34	4698770.37
1993	6602496.03	4698768.17
1994	6602451.13	4698768.06
1995	6602442.00	4698740.38
1996	6602451.97	4698714.88
1997	6602312.86	4698588.22
1998	6602323.88	4698579.79
1999	6602332.02	4698573.82
2000	6602335.03	4698572.31

br.	Y	X
2001	6602313.33	4698588.81
2002	6602327.21	4698604.02
2003	6602315.56	4698591.26
2004	6602350.18	4698629.45
2005	6602359.49	4698640.46
2006	6602365.34	4698599.43
2007	6602340.71	4698618.82
2008	6602344.60	4698622.57
2009	6602315.41	4698645.70
2010	6602329.67	4698634.39
2011	6602336.81	4698925.92
2012	6602360.35	4698919.27
2013	6602363.08	4698921.46
2014	6602361.39	4698951.92
2015	6602366.94	4698944.09
2016	6602376.43	4698932.43
2017	6602109.41	4698876.08
2018	6602087.85	4698897.35
2019	6602066.82	4698921.47
2020	6602081.70	4698904.39
2021	6602067.60	4698877.48
2022	6602060.26	4698885.26
2023	6602045.12	4698904.76
2024	6602070.52	4698874.39
2025	6602084.72	4698860.10
2026	6602075.04	4698869.60
2027	6602028.44	4698949.32
2028	6602029.05	4698947.12
2029	6602033.94	4698929.55
2030	6602025.38	4698943.88
2031	6602036.68	4698912.88
2032	6602023.95	4698947.81
2033	6601966.64	4698966.60
2034	6601948.53	4698960.26
2035	6601961.13	4698882.49
2036	6601960.00	4698887.34
2037	6601957.47	4698896.42
2038	6601955.70	4698901.27
2039	6601953.68	4698908.08
2040	6601951.34	4698915.41
2041	6601946.45	4698929.82
2042	6601939.77	4698957.00
2043	6602018.77	4698962.00
2044	6602044.93	4698954.87
2045	6602034.53	4698951.37
2046	6602040.86	4698965.94
2047	6602043.72	4698958.50
2048	6602040.28	4698966.97
2049	6602032.53	4698990.13
2050	6602034.75	4698984.26
2051	6602036.15	4698980.14
2052	6602037.87	4698974.54
2053	6602039.56	4698969.24
2054	6602024.96	4699010.51
2055	6602025.63	4699008.15
2056	6602027.38	4699003.72
2057	6602029.15	4698999.06
2058	6602011.04	4699053.80
2059	6602014.49	4699044.51
2060	6602020.79	4699025.34
2061	6602021.07	4699024.34
2062	6602024.31	4698943.44
2063	6601974.31	4699008.67
2064	6602226.79	4698835.53
2065	6602226.03	4698836.41
2066	6602256.33	4698858.83
2067	6602271.77	4698871.01
2068	6602164.73	4698804.29
2069	6602179.09	4698793.30
2070	6602197.09	4698779.95
2071	6602298.30	4699033.01
2072	6602309.27	4699016.45
2073	6602296.60	4699035.57
2074	6602286.25	4699051.17
2075	6602278.94	4698969.97
2076	6602246.54	4699011.94
2077	6602226.68	4699039.52
2078	6602244.49	4699014.78
2079	6602206.49	4698943.96
2080	6602195.14	4698948.09

br.	Y	X
2081	6602216.84	4698924.34
2082	6602211.03	4698930.48
2083	6602244.46	4698939.67
2084	6602241.79	4698936.95
2085	6602262.33	4698957.88
2086	6602264.66	4698955.51
2087	6602277.14	4698940.87
2088	6602250.61	4698971.25
2089	6602258.44	4698961.86
2090	6602380.37	4698308.49
2091	6602368.71	4698292.25
2092	6602392.63	4698325.04
2093	6602384.23	4698313.58
2094	6602397.56	4698331.77
2095	6602481.63	4698417.33
2096	6602460.60	4698427.33
2097	6602477.96	4698411.12
2098	6602461.79	4698384.91
2099	6602421.09	4698366.25
2100	6602426.30	4698362.58
2101	6602437.99	4698354.11
2102	6602449.99	4698305.06
2103	6602431.41	4698277.81
2104	6602427.83	4698272.08
2105	6602428.01	4698267.58
2106	6602430.73	4698267.00
2107	6602440.27	4698265.10
2108	6602440.45	4698266.08
2109	6602440.02	4698269.92
2110	6602463.05	4698293.71
2111	6602451.61	4698307.44
2112	6602375.58	4698380.35
2113	6602352.10	4698421.39
2114	6602364.06	4698443.21
2115	6602389.58	4698449.09
2116	6602483.43	4698420.31
2117	6602500.88	4698409.83
2118	0002488.84	4698429.63
2119	6602483.22	4698397.93
2120	6602483.90	4698399.07
2121	6602480.30	4698401.40
2122	6602474.43	4698405.07
2123	6602486.67	4698395.74
2124	6602500.78	4698386.78
2125	6602503.46	4698408.30
2126	6602513.49	4698401.89
2127	6602521.83	4698445.43
2128	6602523.78	4698441.87
2129	6602524.07	4698436.86
2130	6602401.23	4698337.43
2131	6602400.21	4698335.86
2132	6602464.02	4698295.34
2133	6602473.58	4698339.70
2134	6602459.33	4698318.78
2135	6602475.21	4698342.74
2136	6602488.45	4698332.72
2137	6602475.54	4698342.49
2138	6602474.69	4698385.03
2139	6602472.66	4698381.80
2140	6602465.59	4698370.03
2141	6602478.32	4698382.79
2142	6602516.22	4698400.34
2143	6602467.95	4698440.28
2144	6602421.41	4698418.09
2145	6602403.17	4698428.84
2146	6602404.43	4698389.19
2147	6602433.84	4698439.26
2148	6602414.40	4698450.09
2149	6602456.19	4698429.70
2150	6602440.99	4698438.58
2151	6602432.82	4698388.52
2152	6602433.50	4698388.13
2153	6602387.62	4698427.77
2154	6602390.74	4698425.28
2155	6602379.23	4698432.87
2156	6602385.56	4698442.45
2157	6602666.86	4698356.95
2158	6602501.28	4698295.89
2159	6602496.02	4698301.37
2160	6602490.48	4698306.13

br.	Y	X
2161	6602485.35	4698309.53
2162	6602509.78	4698298.51
2163	6602542.46	4698356.70
2164	6602498.53	4698315.18
2165	6602508.93	4698307.13
2166	6602530.66	4698339.09
2167	6602513.45	4698303.63
2168	6602563.96	4698343.78
2169	6602551.70	4698379.26
2170	6602549.93	4698376.16
2171	6602546.95	4698371.47
2172	6602543.13	4698365.63
2173	6602567.59	4698363.31
2174	6602570.18	4698368.08
2175	6602574.85	4698349.11
2176	6602581.88	4698375.58
2177	6602581.21	4698374.58
2178	6602587.35	4698371.15
2179	6602575.04	4698379.48
2180	6602545.52	4698396.53
2181	6602547.39	4698395.24
2182	6602557.55	4698389.45
2183	6602614.97	4698354.39
2184	6602620.93	4698350.58
2185	6602637.94	4698357.82
2186	6602645.03	4698369.89
2187	6602648.83	4698367.64
2188	6602634.78	4698376.48
2189	6602563.59	4698420.74
2190	6602557.38	4698412.45
2191	6602593.41	4698393.01
2192	6602611.25	4698410.95
2193	6602674.30	4698420.10</



# KOORDINATE TAČKA PARCELACIJE

br.	Y	X
2241	6602239.88	4698848.68
2242	6602241.33	4698847.00
2243	6602312.00	4698856.61
2244	6602282.27	4698885.69
2245	6602285.85	4698882.19
2246	6602303.82	4698345.89
2247	6602298.11	4698349.50
2248	6602269.54	4698379.74
2249	6602264.03	4698371.06
2250	6602280.35	4698398.21
2251	6602275.59	4698390.20
2252	6602270.21	4698380.80
2253	6602284.53	4698405.81
2254	6602281.24	4698399.70
2255	6602251.53	4698351.37
2256	6602228.41	4698407.40
2257	6602225.63	4698402.62
2258	6602229.35	4698409.00
2259	6602218.35	4698391.03
2260	6602321.75	4698373.98
2261	6602355.33	4698387.17
2262	6602342.65	4698367.69
2263	6602363.31	4698359.06
2264	6602371.33	4698313.96
2265	6602336.78	4698434.32
2266	6602328.93	4698438.30
2267	6602353.77	4698424.44
2268	6602348.10	4698427.74
2269	6602339.27	4698432.87
2270	6602276.48	4698495.22
2271	6602266.67	4698437.42
2272	6602262.87	4698439.21
2273	6602249.76	4698446.51
2274	6602242.73	4698473.54
2275	6602281.88	4698462.87
2276	6602321.68	4698528.50
2277	6602320.49	4698526.63
2278	6602318.88	4698524.10
2279	6602193.66	4698421.72
2280	6602177.34	4698395.73
2281	6602204.71	4698497.74
2282	6602205.32	4698498.78
2283	6602229.48	4698541.95
2284	6602221.69	4698526.91
2285	6602214.24	4698516.21
2286	6602232.20	4698505.81
2287	6602213.88	4698515.51
2288	6602220.52	4698485.83
2289	6602239.13	4698478.38
2290	6602232.00	4698505.47
2291	6602226.98	4698496.99
2292	6602237.31	4698514.70
2293	6602254.28	4698505.38
2294	6602252.28	4698549.23
2295	6602247.72	4698532.81
2296	6602505.20	4698292.41
2297	6602490.71	4698273.17
2298	6602528.42	4698282.64
2299	6602509.98	4698257.01
2300	6602529.50	4698292.20
2301	6602525.09	4698285.03
2302	6602536.45	4698274.49
2303	6602524.34	4698256.58
2304	6602526.60	4698259.84
2305	6602528.93	4698263.31
2306	6602529.19	4698263.13
2307	6602536.25	4698273.32
2308	6602535.85	4698273.60
2309	6602541.78	4698281.07
2310	6602284.17	4698615.74
2311	6602297.80	4698569.36
2312	6602282.42	4698577.78
2313	6602148.62	4698845.13
2314	6602136.81	4698852.73
2315	6602136.26	4698853.08
2316	6602155.97	4698840.84
2317	6602178.02	4698843.09
2318	6601881.21	4698998.44
2319	6601887.09	4698971.97
2320	6601892.19	4698943.63

br.	Y	X
2321	6601897.93	4698915.68
2322	6601904.06	4698893.52
2323	6601909.42	4698873.80
2324	6601912.45	4698863.11
2325	6601925.06	4699017.77
2326	6601926.34	4699013.22
2327	6601933.19	4698987.26
2328	6601936.34	4698973.98
2329	6601938.60	4698961.35
2330	6602139.04	4699046.46
2331	6602143.04	4699027.41
2332	6602145.37	4699015.60
2333	6602147.26	4699005.31
2334	6602148.64	4698998.61
2335	6602147.92	4698995.06
2336	6602138.66	4699048.56
2337	6602126.16	4699102.07
2338	6602129.73	4699086.82
2339	6602136.27	4699061.76
2340	6602137.17	4699056.77
2341	6602240.08	4698900.88
2342	6602230.17	4698910.79
2343	6602223.11	4698917.72
2344	6602223.02	4698917.82
2345	6602268.86	4698874.36
2346	6602260.15	4698881.78
2347	6602247.67	4698893.30
2348	6602295.23	4698846.62
2349	6602288.93	4698853.33
2350	6602286.64	4698855.54
2351	6602274.68	4698867.65
2352	6602494.73	4699055.58
2353	6602475.47	4699046.71
2354	6602461.02	4699040.06
2355	6601968.60	4698865.69
2356	6601965.69	4698871.88
2357	6601962.91	4698880.00
2358	6601994.69	4698840.52
2359	6601983.87	4698851.69
2360	6602009.72	4698825.49
2361	6601999.16	4698835.98
2362	6602029.69	4698806.94
2363	6602023.32	4698812.86
2364	6602311.67	4698717.24
2365	6602222.09	4698611.72
2366	6602205.21	4698583.54
2367	6602204.65	4698582.15
2368	6602204.58	4698580.65
2369	6602205.01	4698579.21
2370	6602238.83	4698639.67
2371	6602056.03	4698635.23
2372	6602094.50	4698622.76
2373	6602086.07	4698626.44
2374	6602078.13	4698629.23
2375	6602076.82	4698629.59
2376	6602104.18	4698616.89
2377	6602104.78	4698618.27
2378	6602340.29	4698402.57
2379	6602330.12	4698406.76
2380	6602328.32	4698407.50
2381	6602316.21	4698377.45
2382	6602306.23	4698311.02
2383	6602294.85	4698317.04
2384	6602285.52	4698322.21
2385	6602284.11	4698327.88
2386	6602393.37	4698370.36
2387	6602383.24	4698353.12
2388	6602378.79	4698353.41
2389	6602377.91	4698353.93
2390	6602376.30	4698351.18
2391	6602725.79	4699120.01
2392	6602741.40	4699104.35
2393	6602681.46	4699097.56
2394	6602711.97	4699115.86
2395	6602712.23	4699115.44
2396	6602716.00	4699113.60
2397	6602724.93	4699114.72
2398	6602724.30	4699119.68
2399	6602499.51	4699129.34
2400	6602474.90	4699126.24

br.	Y	X
2401	6602505.08	4699114.72
2402	6602478.15	4699092.38
2403	6602516.86	4699076.81
2404	6602521.95	4699053.68
2405	6602644.61	4699157.43
2406	6602631.76	4699202.17
2407	6602630.80	4699201.89
2408	6602630.14	4699201.50
2409	6602629.63	4699201.01
2410	6602629.25	4699200.47
2411	6602629.01	4699199.94
2412	6602633.59	4699187.82
2413	6602641.91	4699164.87
2414	6602643.23	4699161.23
2415	6602428.64	4699113.22
2416	6602419.47	4699138.79
2417	6602422.92	4699146.40
2418	6602444.63	4699154.59
2419	6602449.58	4699122.23
2420	6602438.81	4699084.89
2421	6602447.27	4699061.30
2422	6602234.68	4698459.20
2423	6602233.62	4698455.69
2424	6602235.06	4698454.88
2425	6602233.23	4698451.64
2426	6602258.53	4698501.72
2427	6602251.73	4698489.59
2428	6602453.86	4698317.51
2429	6602456.91	4698316.23
2430	6602447.99	4699155.80
2431	6602475.83	4699165.25
2432	6602466.29	4699068.27
2433	6602154.23	4698927.62
2434	6602193.16	4698917.21
2435	6602193.40	4698917.38
2436	6602175.29	4698903.93
2437	6602164.53	4698895.94
2438	6602671.74	4699138.96
2439	6602089.97	4698894.93
2440	6602521.34	4698445.89
2441	6602524.08	4698448.77
2442	6602524.46	4698448.36
2443	6602510.07	4698455.73
2444	6602514.60	4698452.32
2445	6602552.94	4699096.16
2446	6602537.67	4699087.21
2447	6602529.95	4699082.76
2448	6602180.51	4698733.57
2449	6602179.65	4698734.53
2450	6602191.33	4698743.98
2451	6602196.15	4698747.88
2452	6602516.52	4699134.54
2453	6602513.38	4699141.14
2454	6602512.35	4699141.57
2455	6602514.20	4699152.89
2456	6602508.53	4699157.67
2457	6602516.00	4699157.06
2458	6602514.49	4699157.18
2459	6602039.59	4698830.41
2460	6602018.39	4698852.06
2461	6602091.70	4698786.89
2462	6601969.89	4698863.25
2463	6601929.92	4698832.62
2464	6601923.89	4698834.03
2465	6601920.09	4698843.21
2466	6601919.34	4698845.53
2467	6601917.62	4698851.18
2468	6601974.53	4698958.19
2469	6601998.99	4698890.84
2470	6601997.00	4698884.03
2471	6602700.12	4698333.64
2472	6602700.09	4698327.47
2473	6602701.10	4698314.07
2474	6602702.08	4698307.81
2475	6602702.63	4698301.41
2476	6602666.38	4698357.24
2477	6602677.20	4698377.87
2478	6602683.40	4698379.70
2479	6602690.03	4698375.95
2480	6602697.33	4698364.72

br.	Y	X
2481	6602699.03	4698350.21
2482	6602129.10	4698510.10
2483	6602120.00	4698495.45
2484	6602111.01	4698481.57
2485	6602153.55	4698502.75
2486	6602132.97	4698515.38
2487	6602161.39	4698490.74
2488	6602157.82	4698493.64
2489	6602149.69	4698489.61
2490	6602128.37	4698457.23
2491	6602127.92	4698456.42
2492	6602166.84	4698485.05
2493	6602166.67	4698478.05
2494	6602169.94	4698482.72
2495	6602140.02	4698439.46
2496	6602143.59	4698444.99
2497	6602157.28	4698464.62
2498	6602130.63	4698605.33
2499	6602134.32	4698603.72
2500	6602148.74	4698595.94
2501	6602157.30	4698589.28
2502	6602162.35	4698586.07
2503	6602185.05	4698575.15
2504	6602187.19	4698569.63
2505	6602169.84	4698535.05
2506	6602159.78	4698515.02
2507	6602157.26	4698503.12
2508	6602154.27	4698500.29
2509	6602152.40	4698501.01
2510	6602640.69	4699154.29
2511	6602684.44	4699146.05
2512	6602625.16	4699136.33
2513	6602635.73	4699121.94



# KOORDINATE TAČAKA PARCELACIJE

br.	Y	X
2561	6602539.02	4699084.19
2562	6602543.95	4699076.77
2563	6602526.71	4699077.64
2564	6602554.87	4699061.34
2565	6602570.66	4699039.01
2566	6602591.59	4699120.11
2567	6602565.51	4699112.28
2568	6602564.41	4699112.13
2569	6602563.29	4699112.20
2570	6602562.21	4699112.50
2571	6602561.22	4699113.01
2572	6602560.34	4699113.70
2573	6602588.85	4699066.44
2574	6602596.71	4699053.63
2575	6602601.40	4699045.99
2576	6602579.50	4699082.69
2577	6602579.00	4699082.48
2578	6602581.02	4699108.58
2579	6602559.63	4699114.56
2580	6602561.69	4699111.12
2581	6602565.92	4699104.05
2582	6602593.61	4699088.65
2583	6602572.65	4699092.83
2584	6602589.55	4698902.68
2585	6602575.94	4698886.14
2586	6602609.86	4698889.34
2587	6602621.75	4698904.55
2588	6602610.09	4698889.64
2589	6602570.68	4698915.13
2590	6602583.85	4698931.72
2591	6602557.80	4698898.10
2592	6602568.19	4698911.99
2593	6602532.86	4698938.37
2594	6602587.44	4698868.41
2595	6602571.11	4698878.57
2596	6602567.76	4698876.79
2597	6602517.35	4698912.02
2598	6602509.27	4698911.04
2599	6602544.21	4698860.10
2600	6602561.70	4698878.39
2601	6602563.04	4698883.59
2602	6602547.97	4698892.97
2603	6602522.47	4698844.60
2604	6602526.00	4698848.29
2605	6602527.10	4698847.42
2606	6602532.46	4698847.81
2607	6602495.04	4698866.43
2608	6602494.48	4698866.87
2609	6602510.33	4698854.05
2610	6602504.11	4698859.09
2611	6602511.19	4698853.38
2612	6602527.53	4698871.59
2613	6602512.22	4698882.13
2614	6602520.57	4698876.38
2615	6602493.57	4698894.98
2616	6602532.28	4698902.73
2617	6602506.38	4698993.74
2618	6602507.55	4698995.36
2619	6602507.84	4699000.42
2620	6602541.98	4698968.21
2621	6602524.42	4698980.80
2622	6602601.21	4698947.97
2623	6602589.48	4698934.33
2624	6602589.26	4698934.30
2625	6602573.32	4698945.74
2626	6602604.35	4698949.32
2627	6602607.87	4698920.96
2628	6602591.92	4698932.40
2629	6602591.90	4698932.56
2630	6602603.58	4698946.13
2631	6602607.12	4698947.17
2632	6602624.53	4698909.01
2633	6602637.87	4698924.66
2634	6602640.19	4698923.01
2635	6602641.38	4698927.14
2636	6602657.15	4698910.37
2637	6602656.87	4698910.58
2638	6602657.50	4698910.79
2639	6602703.71	4698900.65

br.	Y	X
2641	6602706.71	4698892.36
2642	6602721.41	4698902.70
2643	6602686.70	4698873.55
2644	6602688.57	4698875.72
2645	6602672.54	4698858.39
2646	6602695.76	4699049.23
2647	6602704.01	4699042.99
2648	6602727.98	4699023.58
2649	6602595.26	4699000.82
2650	6602651.73	4698939.61
2651	6602686.91	4698887.87
2652	6602678.32	4698879.12
2653	6602676.01	4698876.52
2654	6602671.82	4698875.76
2655	6602670.75	4698874.65
2656	6602670.39	4698874.90
2657	6602660.02	4698882.82
2658	6602660.01	4698883.08
2659	6602672.88	4698898.39
2660	6602697.01	4698895.94
2661	6602631.77	4698988.47
2662	6602628.68	4698991.16
2663	6602614.42	4699006.11
2664	6602607.24	4699013.80
2665	6602639.65	4698981.60
2666	6602644.18	4698894.92
2667	6602626.73	4698907.43
2668	6602657.47	4699004.77
2669	6602674.92	4698902.13
2670	6602621.52	4698937.28
2671	6602675.02	4698952.17
2672	6602714.70	4698914.81
2673	6602699.62	4698929.86
2674	6602685.89	4698942.89
2675	6602662.38	4698931.38
2676	6602669.90	4698925.57
2677	6602668.91	4698926.33
2678	6602666.59	4698928.13
2679	6602724.56	4698905.21
2680	6602732.59	4698909.89
2681	6602740.64	4698916.16
2682	6602756.16	4698927.13
2683	6602512.47	4698926.49
2684	6602471.77	4698884.82
2685	6602476.73	4698889.90
2686	6602529.78	4698970.99
2687	6602501.21	4698990.49
2688	6602492.31	4698991.27
2689	6602547.66	4698957.67
2690	6602565.54	4698944.85
2691	6602641.06	4698890.70
2692	6602635.92	4698848.81
2693	6602644.95	4698849.27
2694	6602648.87	4698852.19
2695	6602652.71	4698855.23
2696	6602656.47	4698858.33
2697	6602660.15	4698861.52
2698	6602666.21	4698867.17
2699	6602665.94	4698871.70
2700	6602654.41	4698880.50
2701	6602596.17	4698873.55
2702	6602538.73	4698910.04
2703	6602538.35	4698909.54
2704	6602557.45	4698897.65
2705	6602454.68	4698964.05
2706	6602473.85	4698950.50
2707	6602486.68	4698942.20
2708	6602501.44	4698933.40
2709	6602470.50	4698885.83
2710	6602569.17	4698972.90
2711	6602556.96	4698957.47
2712	6602601.59	4698951.46
2713	6602539.59	4698998.60
2714	6602542.24	4698968.52
2715	6602590.69	4698965.36
2716	6602587.83	4698962.13
2717	6602607.55	4698886.39
2718	6602630.54	4698852.16
2719	6602639.92	4698863.30

br.	Y	X
2721	6602625.74	4698873.66
2722	6602640.41	4698891.17
2723	6602628.17	4698876.50
2724	6602569.59	4698915.85
2725	6602602.46	4698918.38
2726	6602550.77	4698925.67
2727	6602552.12	4698927.42
2728	6602520.09	4698921.72
2729	6602534.16	4698940.07
2730	6602515.92	4698952.35
2731	6602554.58	4698983.36
2732	6602571.48	4698975.86
2733	6602585.71	4698959.74
2734	6602620.87	4698936.51
2735	6602670.71	4698900.55
2736	6602571.96	4699004.25
2737	6602557.79	4698987.22
2738	6602688.03	4698872.45
2739	6602699.57	4698886.82
2740	6602705.13	4698858.26
2741	6602506.77	4699036.13
2742	6602515.77	4699021.07
2743	6602516.01	4699020.69
2744	6602518.20	4699017.14
2745	6602496.45	4699052.33
2746	6602499.26	4699047.92
2747	6602502.50	4699042.83
2748	6602505.85	4699037.58
2749	6602457.17	4699038.29
2750	6602450.60	4699052.01
2751	6602499.08	4699006.97
2752	6602490.55	4699007.34
2753	6602478.49	4699015.69
2754	6602471.06	4699021.56
2755	6602681.09	4698946.89
2756	6602634.56	4698952.89
2757	6602556.17	4699033.19
2758	6602571.34	4699038.21
2759	6602538.09	4699026.19
2760	6602590.05	4698995.17
2761	6602562.58	4699019.01
2762	6602561.09	4699024.32
2763	6602629.60	4698969.76
2764	6602625.52	4698972.86
2765	6602624.91	4698972.06
2766	6602619.31	4698971.30
2767	6602605.18	4698982.05
2768	6602527.75	4699010.64
2769	6602551.90	4699020.95
2770	6602554.40	4699019.48
2771	6602605.92	4699015.22
2772	6602597.32	4699024.73
2773	6602593.70	4699028.59
2774	6602627.20	4698959.22
2775	6602630.34	4698962.91
2776	6602629.71	4698963.39
2777	6602629.09	4698969.16
2778	6602627.10	4698959.09
2779	6602602.03	4698978.17
2780	6602618.45	4698965.67
2781	6602211.36	4699041.93
2782	6602088.55	4699014.16
2783	6602107.36	4698972.39
2784	6602114.81	4698970.60
2785	6602095.09	4698956.03
2786	6602097.18	4698964.80
2787	6602088.73	4698982.32
2788	660191.45	4698964.34
2789	6602019.91	4698910.77
2790	6602006.68	4698909.23
2791	6602005.48	4698906.67
2792	6602008.47	4698898.43
2793	6602014.61	4698896.58
2794	6602019.32	4698900.06
2795	6602759.87	4699174.18
2796	6602751.94	4699212.74
2797	6602750.44	4699220.09
2798	6602746.17	4699223.31
2799	6602701.29	4699214.16

br.	Y	X
2801	6602696.34	4699205.04
2802	6602700.91	4699197.31
2803	6602697.38	4699185.10
2804	6602693.16	4699192.74
2805	6602687.62	4699202.18
2806	6602683.20	4699209.93
2807	6602678.92	4699211.87
2808	6602651.79	4699206.29
2809	6602650.00	4699205.93
2810	6602644.69	4699204.85
2811	6602639.10	4699203.66
2812	6602637.36	4699165.86
2813	6602630.13	4699186.13
2814	6602624.90	4699200.80
2815	6602593.51	4699190.16
2816	6602593.80	4699187.68
2817	6602594.81	4699184.61
2818	6602598.31	4699195.49
2819	6602576.56	4699191.25
2820	6602583.37	4699187.39
2821	6602498.88	4699158.68
2822	6602496.99	4699167.94
2823	6602499.80	4699172.58
2824	6602549.11	4699185.40
2825	6602283.26	4699021.61
2826	6602262.48	4699056.65
2827	6602264.99	4699065.59
2828	6602272.10	4699070.12
2829	6602244.11	4699051.66
2830	6602251.40	4699049.73
2831	6602263.18	4699028.38
2832	6602206.33	4699024.53
2833	6602217.86	4699033.08
2834	6602159.02	4698989.59
2835	6602141.87	4698918.21
2836	6602137.52	4698918.98



	<p>-Saobraćajnice sekundarne mreže projektovati sa poprečnim nagibima kolovoza i trotoara <math>i_p=2\%(2.5\%)</math>.</p> <p>-Kolovoznu konstrukciju za sve saobraćajnice sračunati na osnovu ranga saobraćajnice, odnosno pretpostavljenog saobraćajnog opterećenja za period od 20 god. i geološko-geomehaničkog elaborata iz kojeg se vidi nosivost posteljice prirodnog terena.</p> <p>Kolovoz kod svih saobraćajnica izvesti sa zastorom od asfalta.</p> <p>-Oivičenje kolovoza raditi od betonskih ivičnjaka 20/24cm a na mjestima prilaza urbanističkim parcelama koristiti oborene ivičnjake 18/24cm.</p> <p>-Pored toga na javnim površinama u funkciji saobraćaja (na proširenjima ili kolsko-pješačkim površinama) moguće je izvesti kombinacije uličnog zelenila koje pri tom ne bi ugrožavalo preglednost odnosno bezbjednost saobraćaja.</p> <p>-Prije izvođenja saobraćajnica izvesti sve potrebne ulične instalacije koje su predviđene planom a nalaze se u poprečnom profilu.</p> <p>Planom je navedeno: "Prilikom izrade Glavnih projekata planiranih ulica, parkinga i pješačkih staza, može doći do izvjesnih korekcija u odnosu na zadate parametre u planu u cilju uklapanja u postojeće stanje i radi iznalaženja najboljih saobraćajnih rješenja." (strana 42 tekstualnog dijela plana).</p>
2.2.	<b>Pravila parcelacije, građevinska i regulaciona linija, odnos prema susjednim parcelama</b>
	Prilikom izrade tehničke dokumentacije poštovati važeći Pravilnik o načinu izrade i sadržini tehničke dokumentacije za građenje objekata, kojim je propisano da tehnička dokumentacija sadrži grafički prikaz trase objekta na ažurnim kat. podlogama, kao i tehničke propise, normative i standarde za projektovanje ove vrste objekata.
3	<b>PREPORUKE ZA SMANJENJE UTICAJA I ZAŠTITU OD ZEMLJOTRESA, KAO I DRUGE USLOVE ZA ZAŠTITU OD ELEMENTARNIH NEPOGODA I TEHNIČKO-TEHNOLOŠKIH I DRUGIH NESREĆA</b>
	Potrebno je da se pri izgradnji na predmetnom prostoru, skupom urbanističkih i građevinskih karakteristika zadovolje potrebe zaštite i to pre svega tako da se smanje dejstva eventualnog mogućeg razaranja objekata. Zbog toga je, pri planiranju na ovom prostoru obavezno obezbediti mere zaštite od elementarnih i drugih većih nepogoda. U tom smislu, sa aspekta zaštite na predmetnom području su razrađene i sprovedene mere i dati parametri povredivosti. Kao optimalna mera za smanjenje povredivosti, ostvaren je koncept kojim je predmetni prostor koncipiran kao urbani sistem, koji će funkcionisati u sklopu celokupnog naselja.
4	<b>USLOVI I MJERE ZAŠTITE ŽIVOTNE SREDINE</b>
	Tehničkom dokumentacijom poštovati odredbe koje se odnose na zaštitu životne sredine u skladu sa odredbama Zakona o procjeni uticaja na životnu sredinu („Službeni list CG“, br.40/10, 73/10, 40/11, 27/13, 52/16) i Zakonom za zaštitu prirode („Službeni list CG“, br.54/16).
5	<b>USLOVI ZA PEJZAŽNO OBLIKOVANJE</b>
	Projektom obuhvatiti i fazu hortikulture shodno grafičkom prilogu ovih uslova. Zbog ekstremnih insolacionih uslova, ulično zelenilo i zelenilo na parkinzima rasporediti tako da su u sjenci pješačke i biciklističke staze kao i parkirališta u periodu dana kada je sunce najjače.



Crna Gora  
Glavni Grad Podgorica  
Sekretarijat za planiranje prostora i  
održivi razvoj

Broj: 08-332/23-1716  
Podgorica, 12.10.2023.godine

Glavni grad Podgorica



GRAFIČKI PRILOG – Plan pejzažne arhitekture  
Izvod iz DUP-a „Zabjelo 8” u Podgorici

7



# KOORDINATE TAČKA PARCELACIJE

br.	Y	X
2881	6602059.93	4698571.42
2882	6602710.71	4698969.70
2883	6602659.70	4699019.19
2884	6602645.24	4699037.02
2885	6602648.13	4699043.10
2886	6602725.56	4698955.30
2887	6602735.77	4698927.17
2888	6602745.22	4698937.23
2889	6602745.42	4698937.04
2890	6602726.61	4698954.24
2891	6602734.42	4698947.37
2892	6602718.41	4698911.12
2893	6602716.52	4698909.65
2894	6602719.64	4698949.20
2895	6602589.60	4699032.96
2896	6602627.63	4699040.45
2897	6602635.70	4699036.46
2898	6602653.78	4699013.09
2899	6602535.95	4699063.76
2900	6602537.05	4699062.11
2901	6602553.68	4699037.11
2902	6602542.87	4699053.36
2903	6602175.77	4698524.40
2904	6602655.37	4698262.26
2905	6602599.96	4698253.60
2906	6602036.78	4698666.96
2907	6602083.73	4698684.61
2908	6602088.87	4698682.30
2909	6602017.45	4698652.45
2910	6602021.24	4698658.70
2911	6602032.55	4698665.37
2912	6602621.09	4699049.60
2913	6602625.88	4699057.39
2914	6602622.44	4699067.93
2915	6602618.71	4699079.33
2916	6602137.89	4698890.46
2917	6602138.62	4698894.60
2918	6602654.68	4699012.22
2919	6602345.47	4698449.28
2920	6602539.94	4698448.41
2921	6602531.40	4698454.94
2922	6602531.24	4698455.06
2923	6602748.80	4698604.06
2924	6602744.35	4698602.62
2925	6602733.91	4698609.45
2926	6602733.32	4698616.53
2927	6602763.67	4698644.40
2928	6602757.81	4698627.71
2929	6602706.26	4699062.68
2930	6602704.87	4699060.48
2931	6602208.15	4698542.18
2932	6602189.16	4698551.27
2933	6602231.64	4698558.07
2934	6602222.46	4698535.33
2935	6602198.38	4698523.72
2936	6602150.49	4698498.11
2937	6602125.38	4698459.97
2938	6602467.45	4698607.12
2939	6602464.47	4698609.93
2940	6602673.51	4698953.48
2941	6602670.26	4698948.87
2942	6602664.45	4698952.95
2943	6602712.83	4699172.65
2944	6602602.56	4699186.18
2945	6602601.42	4699191.77
2946	6602472.66	4698893.89
2947	6602067.65	4699018.13
2948	6601965.80	4698966.31
2949	6601968.00	4698959.56
2950	6602179.41	4698832.63
2951	6602173.58	4698836.68
2952	6602012.69	4698754.56
2953	6602009.29	4698749.28
2954	6602151.33	4698700.02
2955	6602351.18	4698801.64
2956	6602356.91	4698796.92
2957	6602160.85	4698482.12
2958	6602164.38	4698487.16
2959	6602469.37	4698273.68
2960	6602465.72	4698267.59

br.	Y	X
2961	6602460.83	4698270.52
2962	6602608.09	4698415.18
2963	6602601.84	4698418.61
2964	6602604.57	4698423.61
2965	6602726.74	4698720.88
2966	6602724.36	4698714.19
2967	6602718.99	4698716.10
2968	6602655.11	4698967.42
2969	6602670.87	4698955.78
2970	6602667.96	4698957.93
2971	6602193.12	4698477.85
2972	6602185.58	4698483.50
2973	6602179.56	4698488.17
2974	6602174.24	4698492.85
2975	6602171.03	4698497.21
2976	6602169.16	4698504.72
2977	6602169.85	4698510.23
2978	6602171.78	4698515.18
2979	6602415.09	4698534.51
2980	6602414.66	4698534.83
2981	6602419.78	4698531.00
2982	6602406.28	4698521.46
2983	6602425.24	4698534.69
2984	6602531.66	4699080.28
2985	6602505.25	4699132.53
2986	6602501.80	4699144.38
2987	6602506.27	4699129.85
2988	6602528.28	4699082.35
2989	6602524.62	4699087.69
2990	6602516.26	4699103.64
2991	6602515.71	4699105.06
2992	6602499.17	4699130.21
2993	6602495.44	4699143.08
2994	6602490.92	4699165.17
2995	6602488.96	4699164.77
2996	6602483.86	4699167.79
2997	6602509.94	4699101.97
2998	6602515.17	4699090.62
2999	6602510.18	4699101.32
3000	6602518.83	4699077.92
3001	6602519.97	4699082.99
3002	6602519.08	4699073.57
3003	6602649.33	4698456.17
3004	6602641.44	4698460.41
3005	6602639.47	4698458.71
3006	6602638.95	4698457.81
3007	6602634.59	4698460.27
3008	6602635.07	4698461.10
3009	6602635.59	4698463.56
3010	6602665.84	4698447.31
3011	6602682.46	4698438.72
3012	6602694.99	4698432.72
3013	6602695.51	4698432.44
3014	6602694.27	4698409.23
3015	6602666.99	4698446.69
3016	6602667.17	4698447.00
3017	6602678.07	4698440.82
3018	6602621.17	4698508.04
3019	6602673.51	4698478.07
3020	6602704.47	4698483.02
3021	6602699.89	4698463.09
3022	6602692.74	4698466.28
3023	6602688.30	4698468.63
3024	6602688.47	4698468.94
3025	6602688.72	4698469.37
3026	6602382.78	4698339.51
3027	6602402.18	4698372.53
3028	6602385.41	4698343.98
3029	6602416.88	4698397.55
3030	6602427.59	4698415.77
3031	6602468.74	4698451.81
3032	6602469.33	4698453.92
3033	6602455.15	4698461.40
3034	6602453.41	4698459.73
3035	6602515.35	4698744.35
3036	6602515.27	4698742.19
3037	6602511.51	4698738.58
3038	6602503.75	4698737.63
3039	6602500.94	4698739.26
3040	6602585.26	4699263.72

br.	Y	X
3041	6602609.35	4699266.29
3042	6602583.15	4699281.21
3043	6602583.27	4699280.39
3044	6602583.51	4699274.32
3045	6602584.39	4699270.92
3046	6602609.39	4699265.98
3047	6602609.50	4699265.81
3048	6602610.81	4699254.20
3049	6602611.42	4699248.95
3050	6602611.99	4699244.18
3051	6602612.08	4699243.84
3052	6602612.09	4699243.77
3053	6602579.12	4699301.55
3054	6602559.22	4699297.75
3055	6602582.76	4699283.95
3056	6602581.85	4699289.25
3057	6602581.62	4699290.64
3058	6602603.22	4699241.61
3059	6602543.89	4699227.89
3060	6602544.34	4699223.47
3061	6602544.70	4699219.60
3062	6602545.78	4699208.01
3063	6602541.14	4699254.57
3064	6602542.59	4699240.51
3065	6602543.58	4699230.87
3066	6602543.88	4699227.93
3067	6602536.61	4699293.71
3068	6602536.87	4699291.22
3069	6602540.86	4699256.98
3070	6602612.70	4699239.16
3071	6602613.19	4699235.07
3072	6602614.36	4699225.82
3073	6602615.13	4699224.96
3074	6602616.08	4699220.99
3075	6602582.78	4699205.30
3076	6602568.23	4699202.33
3077	6602547.79	4699197.92
3078	6602547.14	4699198.99
3079	6602617.52	4699215.15
3080	6602615.10	4699214.55
3081	6602613.17	4699211.49
3082	6602606.56	4699210.15
3083	6602588.56	4699234.98
3084	6602589.11	4699230.03
3085	6602590.88	4699220.63
3086	6602592.46	4699211.40
3087	6602593.13	4699207.41
3088	6602588.23	4699237.96
3089	6602586.66	4699252.11
3090	6602238.88	4699061.48
3091	6602242.75	4699072.70
3092	6602235.11	4699102.66
3093	6602655.61	4699011.31
3094	6602693.73	4698974.33
3095	6602405.72	4698550.00
3096	6602414.49	4698543.44
3097	6602632.76	4698467.06
3098	6602633.88	4698468.99
3099	6602635.27	4698471.38
3100	6602423.56	4698536.06
3101	6602418.73	4698539.99
3102	6602585.60	4699260.93
3103	6602522.85	4698749.49
3104	6602521.56	4698750.32
3105	6602445.62	4698564.88



CRNA GORA  
GLAVNI GRAD- PODGORICA  
Sekretarijat za planiranje  
prostora i održivi razvoj  
Broj: 08-332/23-1716

DUP "Zabjelo 8" Podgorica

Podnosilac zahtjeva :  
Agencija za izgradnju i razvoj Podgorice





*Dravić*



# DRUŠTVO SA OGRANIČENOM ODGOVORNOŠĆU "VODOVOD I KANALIZACIJA"

81000 PODGORICA, ul. Zetskih vladara bb,

PIB: 02015641, PDV: 20/31-00109-1

Telefoni: centrala 020/440 300, fax: 440 362, komercijalni tel/fax: 440 361

Vodovodna mreža: 440 309, kanalizacijska mreža: 440 325, tehnička prostora i održivi razvoj

E-mail: vikpg@t-com.me, Web: www.vikpg.co.me

Žiro računi:

PG banka: 550-1105-66

CKB: 510-8284-20

Prva banka CG: 535-9562-08

Hipotekarna banka: 520-9074-13

**CRNA GORA**

**GLAVNI GRAD PODGORICA**

**Sekretarijat za planiranje prostora i održivi razvoj**

Org. jed.	Jed. klas. znak	Redni b. o. j	Prilog	Vrijednost Broj:
08-	332/23-	1716	10	UPI-02-041/23-7763/2

Podgorica, 10. 10. 2023 20

153502, 3000-638/2023

DOO "Vodovod i kanalizacija" Podgorica, postupajući po zahtjevu **Sekretarijata za planiranje prostora i održivi razvoj**, na osnovu člana 74 Zakona o planiranju prostora i izgradnji objekata (Službeni list CG broj 64/17), člana 19 Odluke o javnom vodosnabdijevanju na teritoriji Glavnog grada (Službeni list CG – opštinski propisi br. 027/15 i 034/16), člana 10 Odluke o prikupljanju, prečišćavanju i ispuštanju otpadnih voda na teritoriji Glavnog grada (Službeni list CG – opštinski propisi br. 027/15) i člana 5 Odluke o prikupljanju i ispuštanju atmosferskih voda na teritoriji Glavnog grada (Službeni list CG – opštinski propisi br. 027/15) izdaje

## TEHNIČKE USLOVE PRIKLJUČENJA NA GRADSKI VODOVOD I KANALIZACIJU

Na osnovu zahtjeva Sekretarijata za planiranje prostora i održivi razvoj broj 08-332/23-1716 od 27.09.2023. godine, koji je kod nas evidentiran pod brojem UPI-02-041/23-7763/1 od 29.09.2023. godine, za izdavanje tehničkih uslova priključenja na gradski vodovod i kanalizaciju za izgradnju saobraćajnice radnog naziva „Ulica broj 20“, u zahvatu DUP-a „Zabjelo 8“ u Podgorici, investitora Agencije za izgradnju i razvoj Podgorice d.o.o. (prema urbanističko-tehničkim uslovima 08-332/23-1716 od 29.09.2023. godine, izdatim od strane Sekretarijata za planiranje prostora i održivi razvoj), propisujemo sljedeće tehničke uslove priključenja na gradski vodovod i kanalizaciju. U prilogu dostavljamo situaciju sa ucrtanim postojećim hidrotehničkim instalacijama na predmetnoj lokaciji.

Napominjemo da se u blizini lokacije može naići na priključne cjevovode za koje ovo Društvo ne posjeduje potrebne podatke o visinskom i horizontalnom položaju, jer prilikom izgradnje ovih cjevovoda nije urađen katastar instalacija, a na cjevovodu nijesu izvedeni vodovodni šahtovi, te u sadašnjem stanju nema mogućnosti da ih snimimo i ucrtamo njihov tačan položaj. Prilikom izgradnje saobraćajnice obavezno je da nas pozovete, radi identifikacije istih i eventualne intervencije.

Izgradnju hidrotehničkih instalacija predvidjeti u skladu sa predmetnim DUP-om. DUP-om je u sklopu predmetne saobraćajnice planirana izgradnja svih hidrotehničkih instalacija. Postojeći vodovod PEVG DN90mm je planiran za ukidanje.

DUP je planski dokument koji se mora poštovati, a može se izmijeniti samo po proceduri. Da bi se sprovelo novo tehničko rješenje koje nije u skladu da DUP-om, potrebno je da inicirate izmjenu DUP-a kod nadležnih organa.

Projektnu dokumentaciju predmetne saobraćajnice je potrebno uskladiti sa projektnom dokumentacijom okolnih saobraćajnica, ukoliko postoji, i objekata na ovoj lokaciji i izvedenim stanjem. Sve prikazati na preglednoj situaciji u odgovarajućoj razmjeri, sa svim prikazanim elementima relevantnim za izbor projektnog rješenja i osnovne koncepcije planiranog stanja šireg prostora i njegovog uklapanja u postojeće elemente i ostale faze projekta. Predvidjeti prespajanje svih postojećih priključaka na novi cjevovod.



Prilikom izgradnje predmetne saobraćajnice, voditi računa o postojećim i planiranim cjevovodima i priključcima na isti. Kote poklopaca svih postojećih hidrotehničkih instalacija prilagoditi niveleti saobraćajnice.

U nastavku su navedeni neki od osnovnih principa koji važe na području vodovodnog i kanalizacionog sistema Podgorice, koje je potrebno ispoštovati, ukoliko su planskim dokumentom planirane instalacije vodovoda, fekalne i/ili atmosferske kanalizacije:

#### a) Vodovod

Vodovodne priključke predvidjeti kao grupne, što znači za grupu objekata predvidjeti zajedničko mjesto priključenja na cjevovodu u šahtu minimalnih dimenzija 1.2x1.2x1.2m čiji je detalj neophodno prikazati (osnovu i presjek) - vodoinstalaterski i gradjevinski, sa specifikacijom materijala i pravim dimenzijama fazonskih komada i armatura da bi dokazali usvojene dimenzije šahta.

Šaht obavezno mora biti sa drenažom, penjalicama i poklopcem tako postavljenim da se pri silazu u šaht ne gazi po cijevima. Grupne priključke predvidjeti preko OP komada, a ne ogrlicom, koje predviđamo samo kod potrebe naknadne ugradnje na postojećem cjevovodu, a ne i kod izgradnje novog cjevovoda. Isto se odnosi na sva mjesta ogranaka – obavezno u šahtu. Zatvarače takodje predvidjeti u šahtu, a ne sa podzemnom ugradbenom garniturom, koji se ne ugradjuju u vodovodnom sistemu Podgorice. Za sve šahtove važi prethodno navedeno u vezi neophodnog prikaza detalja osnove i presjeka šahta te minimalnih i usvojenih dimenzija.

Hidrante za protivpožarnu zaštitu, ukoliko se predviđaju, uraditi u svemu prema važećem Pravilniku o tehničkim normativima za hidrantsku mrežu za gašenje požara ("Sl. list SFRJ 3/91"), prema kojem se postavljaju nadzemni hidranti, a samo u slučaju ako ometaju saobraćaj, postavljaju se podzemni hidranti na nezakrčenom i dostupnom mjestu. Ispred hidranta predvidjeti ugradnju zatvarača u šahtu.

Ukoliko se predviđaju javne česme, hidranti za zalivanje zelenih površina, ili hidranti za protivpožarnu zaštitu, obavezno predvidjeti šaht sa vodomjerom za mjerenje utroška vode.

Svi vodomjeri koji se ugradjuju moraju biti klase C, sa mesinganim, horizontalnim kućištem, impulsnim mehanizmom i radio modulom za daljinsko očitavanje, sa magnetnim ventilom prije i propusnim ventilom poslije vodomjera, koji su prilagodjeni usvojenom programu i opremi d.o.o. "Vodovod i kanalizacija" Podgorice. Vodomjeri moraju biti sa horizontalnom osovinom, baždareni i moraju imati plombu Metrološkog zavoda Crne Gore sa oznakom ME.

#### b) Fekalna kanalizacija

Neophodno je fekalnu kanalizaciju projektovati do postojeće fekalne kanalizacije, i sve to potvrditi tačnim dužinama, položajem i padovima.

Iz svakog revizionog okna planiranog fekalnog kolektora bilo bi potrebno i poželjno ostaviti priključne kanale na obje strane ulice (zavisno od uslova na terenu) 1.0 - 2.0m dužine van krajnjih ivica saobraćajnice, kako bi se stvorili uslovi za priključenje planiranih i postojećih objekata koji mu gravitiraju. Te prelaze obavezno predvidjeti i na mjestu postojećih i budućih priključnih saobraćajnica, da bi se izbjeglo naknadno prekopavanje ulice. Kanalizacija se izvodi od atestiranih PVC ili rebrastih PE kanalizacionih cijevi za uličnu kanalizaciju, nosivosti ne manje od SN4.

S obzirom na opterećenost gradske fekalne kanalizacije, napominjemo da nije preporučljivo priključenje podrumskih i suterenskih etaža objekta na fekalnu kanalizaciju gravitaciono.



c) Atmosferska kanalizacija

Za saobraćajnice duž kojih su predviđeni parkinzi, potrebno je predvidjeti separatore za atmosfersku kanalizaciju, sa priloženim prospektom o kvalitetu efluenta nakon prečišćavanja za izabrane separatore, odnosno da li zadovoljava Pravilnik o kvalitetu i sanitarno-tehničkim uslovima za ispuštanje otpadnih voda u recipijent i javnu kanalizaciju, načinu i postupku ispitivanja kvaliteta otpadnih voda, minimalnom broju ispitivanja i sadržaju izvještaja o utvrđenom kvalitetu otpadnih voda („Službeni list Crne Gore“, br. 45/08 od 31. jula 2008). Separator mora da ima i by-pass. Dimenzionisanje vršiti na mjerodavnu kišu vjerovatnoće 20%, trajanja 15 minuta, intenziteta oko 264 l/s/ha.

Kišne vode sa lokacije objekata se ne smiju upuštati direktno u gradsku atmosfersku kanalizaciju, nego prvo u retenzione bazene na lokaciji objekata, koji se prelivaju u gradsku atmosfersku kanalizaciju.

d) Tehnička opremljenost projekta hidrotehničkih instalacija

Bez obzira na poznato pravilo da projekat treba da sadrži sve tekstualne i grafičke priloge za glavni projekat u skladu sa Pravilnikom o načinu izrade i sadržini tehničke dokumentacije za gradjenje objekta (Službeni list CG broj 044/18), ovdje posebno izdvajamo neke od stavki. Za sve ulice koje se rekonstruišu, vrši se usaglašavanje postojećeg, zatečenog stanja, ustanovljenog na licu mjesta, sa trenutno važećim normativima u svim segmentima i detaljima, a što ne mora da se posebno definiše, jer se to podrazumijeva. Neka od tih pravila posebno navodimo u uslovima projektovanja, ali ne znači da ono što nije posebno navedeno, ne mora da se poštuje. To podrazumijeva i obavezno rješenje priključenja svih potrošača na novi cjevovod, ako se predvidja, kao i usaglašavanje sa osnovnim pravilima svakog priključka, a to je ugradnja vodomjera u šahtu ispred objekta i ostalo.

Obavezan dio projekta je osim važećeg katastra i tehničkih uslova priključenja i projektni zadatak potpisan od strane investitora.

Projekat obavezno mora da sadrži preglednu situaciju u odgovarajućoj razmjeri, sa svim prikazanim elementima relevantnim za izbor projektnog rješenja i osnovne koncepcije planiranog stanja šireg prostora i njegovog uklapanja u postojeće elemente i ostale faza projekta, postojeće i planirano stanje objekata po DUP-u.

Svrha pregledne situacije na kojoj insistiramo kao obaveznom dijelu projekta, je da se može sagledati kako koncepcija kompletnog rješenja, tako i veza svih ostalih priloga datih projektom. Zato navodimo kao bitne karakteristike pregledne situacije sljedeće:

- Situacija ne smije da ima ucrtane izohipse planirane saobraćajnice.
- Moraju biti ucrtani samo osnovni elementi rješenja sa dobro vidljivim trasama svake pojedine instalacije, vidljivim oznakama svih čvorova, revizionih okana i slivnika, padovima i profilima instalacija.
- Potrebno je da osim postojeće geodetske podloge, bude nanešen i dio DUP-om planiranih objekata i saobraćajnica.

Ovi uslovi važe 6 (šest) mjeseci od dana izdavanja.

Prilog: Situacija R = 1:2000

Podgorica,  
10.10.2023. godine

VD izvršnog direktora  
Ratko Vujović, dipl.inž.el.





# Legenda

1:2,000



Vodovodna mreža



RO Atmosferske kanalizacije



RO Fekalne kanalizacije





Crna Gora  
Glavni Grad Podgorica  
Sekretarijat za planiranje prostora i  
održivi razvoj

Broj: 08-332/23-1716  
Podgorica, 12.10.2023.godine

Glavni grad Podgorica



GRAFIČKI PRILOG – Katastarsko geodetska podloga  
Izvod iz DUP-a „Zabjelo 8” u Podgorici

1



6	<b>USLOVI I MJERE ZAŠTITE NEPOKRETNIH KULTURNIH DOBARA I NJIHOVE ZAŠTIĆENE OKOLINE</b>
	Ukoliko se pri izradi projektne dokumentacije i izvođenju radova naiđe na tragove ostataka iz prošlosti, investitor je obavezan da o tome obavijesti nadležni organ koji će preduzeti Zakonom propisane mjere u cilju zaštite kulturnog dobra.
7	<b>USLOVI ZA LICA SMANJENE POKRETLJIVOSTI I LICA SA INVALIDITETOM</b>
	Potrebno je obezbediti pristup svakom objektu koji će koristiti lica smanjene pokretljivosti; takođe nivelaciju svih pešačkih staza i prolaza raditi u skladu sa važećim Pravilnikom o bližim uslovima i načinu prilagođavanja objekata za pristup i kretanje lica smanjene pokretljivosti i lica sa invaliditetom („Sl.list CG”, br.48/13 i 44/15).
8	<b>USLOVI ZA POSTAVLJANJE I GRADNJU POMOĆNIH OBJEKATA</b>
	/
9	<b>USLOVI ZA OBJEKTE KOJI MOGU UTICATI NA BEZBJEDNOST VAZDUŠNOG SAOBRAĆAJA</b>
	/
10	<b>USLOVI ZA OBJEKTE KOJI MOGU UTICATI NA PROMJENE U VODNOM REŽIMU</b>
	/
11	<b>MOGUĆNOST FAZNOG GRAĐENJA OBJEKTA</b>
	Moguća je faznost gradnje, kojom se određuje tehničko-tehnološka i funkcionalna cjelina građenja objekta.
12	<b>USLOVI ZA PRIKLJUČENJE NA INFRASTRUKTURU</b>
12.1.	<b>Uslovi priključenja na elektroenergetsku infrastrukturu</b>
	<p>Detaljne podatke o elektroenergetskoj infrastrukturi potrebno je preuzeti iz tekstualnog dijela Detaljnog urbansitičkog plana "Zabjelo 8", koji je dostupan na internet stranici Registra planske dokumentacije:</p> <p><b><a href="http://www.planovidozvole.mrt.gov.me/LAMP/PlanningDocument?m=PG">http://www.planovidozvole.mrt.gov.me/LAMP/PlanningDocument?m=PG</a>, koju vodi Ministarstvo ekologije, prostornog planiranja i urbanizma</b></p> <p>Tehničku dokumentaciju u dijelu elektroenergetskih instalacija potrebno je izraditi u skladu sa planom elektroenergetske infrastrukture, važećim tehničkim propisima i normativima. Prilikom izrade tehničke dokumentacije za fazu elektroenergetske infrastrukture potrebno je poštovati regulative, standarde i normative, te pribaviti saglasnost nadležnog preduzeća. Mjesto i način priključenja objekta na elektroenergetsku mrežu odrediće se nakon izrade tehničke dokumentacije stručne službe CEDIS-a.</p> <p>Prilikom izrade tehničke dokumentacije potrebno je poštovati sljedeće preporuke EPCG:</p> <ul style="list-style-type: none"> <li>- Tehnička preporuka za priključke potrošača na niskonaponsku mrežu TP-2 (II dopunjeno izdanje)</li> <li>- Tehnička preporuka – Tipizacija mjernih mjesta</li> <li>- Uputstvo i tehnički uslovi za izbor i ugradnju ograničavanja strujnoj opterećenja</li> <li>- Tehnička preporuka TP-1b – Distributivna transformatorska stanica DTS-EPCG 10/0.4kV</li> </ul> <p>Javnu rasvjetu projektovati u skladu sa Preporukama za projektovanje, izvođenje i</p>



	održavanje javne rasvjete na području Glavnog grada – Podgorica.
12.2.	<p><b>Uslovi priključenja na vodovodnu i kanalizacionu infrastrukturu</b></p> <p>Tehničku dokumentaciju u dijelu hidrotehničkih instalacija potrebno je izraditi u skladu sa planom hidrotehničke infrastrukture, važećim tehničkim propisima, normativima, i uslovima priključenja na vodovodnu i fekalnu kanalizacionu infrastrukturu, u skladu sa aktom preduzeća "Vodovod i kanalizacija" d.o.o. koji je sastavni dio ovih uslova. Detaljne podatke o hidrotehničkoj infrastrukturnoj mreži i smjernicama za sprovođenje plana u dijelu hidrotehnike (vodovodna, fekalna i atmosferska kanalizacija) potrebno je preuzeti iz tekstualnog dijela Detaljnog urbansitičkog plana "Zabjelo 8", koji je dostupan na internet stranici Registra planske dokumentacije:</p> <p><b><u><a href="http://www.planovidozvole.mrt.gov.me/LAMP/PlanningDocument?m=PG">http://www.planovidozvole.mrt.gov.me/LAMP/PlanningDocument?m=PG</a></u>, koju vodi Ministarstvo održivog razvoja i turizma.</b></p> <p>Instalacije vodovoda i kanalizacije projektovati u svemu prema važećim propisima i normama za tu vrstu objekata, a priključiti ih na gradsku infrastrukturu prema uslovima nadležnog organa koji su sastavni dio ovih UTU –a .</p>
12.3.	<p><b>Uslovi priključenja na saobraćajnu infrastrukturu</b></p> <p>Kontaktne zone predmetne lokacije detaljno je planski razradjena važećim DUP-om koji je definisao regulacione elemente obodnih javnih saobraćajnica i način priključenja na saobraćajnu infrastrukturu.</p> <p>Saobraćajnu infrastrukturu projektovati u svemu prema važećim propisima i normama za tu vrstu objekata.</p> <p><b>NAPOMENA</b> Tekstualni i grafički dio DUP-a "Zabjelo 8" u kojem su detaljno propisani način izgradnje i uslovi za priključenje na infrastrukturnu mrežu na nivou planskog dokumenta, dostupni su u Registru važeće planske dokumentacije na sljedećoj adresi: <b><u><a href="http://www.planovidozvole.mrt.gov.me/LAMP/PlanningDocument?m=PG">http://www.planovidozvole.mrt.gov.me/LAMP/PlanningDocument?m=PG</a></u></b>, kojeg vodi Ministarstvo ekologije, prostornog planiranja i urbanizma.</p>
12.4.	<p><b>Uslovi priključenja na elektronsko komunikacionu infrastrukturu</b></p> <ul style="list-style-type: none"> <li>- sajt na kome se nalaze relevantni propisi u skladu sa kojim se obavlja izrada tehničke dokumentacije <b><u><a href="http://www.ekip.me/regulativa/">http://www.ekip.me/regulativa/</a></u></b>;</li> <li>- sajt na kome Agencija objavljuje podatke o postojećem stanju elektronske komunikacione infrastrukture <b><u><a href="http://ekinfrastuktura.ekip.me/ekip.me">http://ekinfrastuktura.ekip.me/ekip.me</a></u></b> kao i adresu web portala <b><u><a href="http://ekinfrastuktura.ekip.me/ekip/login.jsp">http://ekinfrastuktura.ekip.me/ekip/login.jsp</a></u></b> preko koga sve zainteresovane strane od Agencije za telekomunikacije i poštansku djelatnost mogu da zatraže otvaranje korisničkog naloga, kako bi pristupili georeferenciranoj bazi podataka elektronske komunikacione infrastrukture. Detaljne podatke o elektronsko komunikacionoj infrastrukturnoj mreži i smjernicama za sprovođenje plana u dijelu elektronske komunikacione infrastrukture potrebno je preuzeti iz tekstualnog dijela Detaljnog urbansitičkog plana "Zabjelo 8", koji je dostupan na internet stranici Registra planske dokumentacije:</li> </ul> <p><b><u><a href="http://www.planovidozvole.mrt.gov.me/LAMP/PlanningDocument?m=PG">http://www.planovidozvole.mrt.gov.me/LAMP/PlanningDocument?m=PG</a></u></b>, koju vodi Ministarstvo održivog razvoja i turizma.</p>
13	<b>POTREBA IZRADE GEODETSKIH, GEOLOŠKIH -GEOTEHNIČKIH, INŽENJERSKO-GEOLOŠKIH, HIDROGEOLOŠKIH, GEOMEHANIČKIH I SEIZMIČKIH) PODLOGA, KAO I VRŠENJA GEOTEHNIČKIH ISTRAŽNIH RADOVA I DRUGIH ISPITIVANJA</b>



	/		
14.	<b>POTREBA IZRADE URBANISTIČKOG PROJEKTA</b>		
	/		
15.	<b>NAPOMENA</b> Tekstualni i grafički dio DUP-a "Zabjelo 8" u kojem su detaljno propisani način izgradnje i uslovi za priključenje na infrastrukturnu mrežu na nivou planskog dokumenta, dostupni su u Registru važeće planske dokumentacije na sljedećoj adresi: <a href="http://www.planovidozvole.mrt.gov.me/LAMP/PlanningDocument?m=PG">http://www.planovidozvole.mrt.gov.me/LAMP/PlanningDocument?m=PG</a> , kojeg vodi Ministarstvo ekologije, prostornog planiranja i urbanizma.		
	DOSTAVLJENO: Podnosiocu zahtjeva, Direkciji za inspekcijski nadzor a/a		
	<table border="0" style="width: 100%;"> <tr> <td style="width: 50%; vertical-align: top;"> <b>OBRAĐIVAČ URBANISTIČKO-TEHNIČKIH USLOVA :</b>   Damir Aljošević, spec.sci.arh.    </td> <td style="width: 50%; vertical-align: top;"> <b>OVLAŠĆENO SLUŽBENO LICE RUKOVODILAC SEKTORA ZA IZGRADNJU I LEGALIZACIJU OBJEKATA:</b>  mr Radmila Maljević, dipl.ing. saob.    </td> </tr> </table>	<b>OBRAĐIVAČ URBANISTIČKO-TEHNIČKIH USLOVA :</b>  Damir Aljošević, spec.sci.arh.  	<b>OVLAŠĆENO SLUŽBENO LICE RUKOVODILAC SEKTORA ZA IZGRADNJU I LEGALIZACIJU OBJEKATA:</b> mr Radmila Maljević, dipl.ing. saob.  
<b>OBRAĐIVAČ URBANISTIČKO-TEHNIČKIH USLOVA :</b>  Damir Aljošević, spec.sci.arh.  	<b>OVLAŠĆENO SLUŽBENO LICE RUKOVODILAC SEKTORA ZA IZGRADNJU I LEGALIZACIJU OBJEKATA:</b> mr Radmila Maljević, dipl.ing. saob.  		
	<b>PRILOZI</b>		
	-Grafički prilozi iz planskog dokumenta - Tehnički uslova "Vodovod I kanalizacija", d.o.o. Podgorica		









## LEGENDA:

### DRUMSKI SAOBRAĆAJ

 Ulice u naselju (kolovoz, trotoari i parkinzi)

### ELEMENTI SAOBRAĆAJNICA

 Osovina saobraćajnice

 Tangenta osovine saobraćajnice

 Oznaka mesta priključka

 Oznaka preseka tangenata

 Oznaka preseka saobraćajnica

Ulica br.1  Naziv saobraćajnice

 Javni parking

 Linearno zelenilo

 Građevinska linija GL1

 Građevinska linija-privremena(do ukidanja dalekovoda)

 Regulatorna linija

 Zona zaštite dalekovoda

 granica DUP-a